

# Mitigation of Fretting Fatigue in Ti-6Al-4V through Surface Enhancement

AUTHOR:  
Dr. N. Jayaraman  
Lambda Technologies

## ABSTRACT:

Failure from fretting fatigue affects aircraft engine rotors and blades at the blade dovetail disk post contact faces. A clear understanding of the fundamental mechanisms involved in the mode II shear micro crack initiation, mode I crack propagation and final failure has evolved through many studies. Although a number of test methods with axially loaded specimens, 4-point bend specimens and dovetail features specimens have been used in the various studies, excellent correlation is noted between test results. While earlier studies focused on the mitigation of crack initiation mechanism through coatings and lubrication, the effectiveness of surface compressive residual stress technologies like low plasticity burnishing (LPB) and laser shock peening (LSP) to completely shut down the mode I crack growth process is highlighted. LPB applications to specific engine rotor and blade to mitigate fretting fatigue are described.

Keywords: low plasticity burnishing (LPB), compressive residual stresses, LSP, fretting fatigue, turbine engines, rotors, blade dovetail

## INTRODUCTION:

It has long been recognized that fretting fatigue in contacting metal components that are subjected to cyclic stress conditions can suffer localized severe damage at the edge of contact (EOC), leading to premature failure and reduced fatigue life. Typically, the local damage at the edge of contact manifests itself in crack initiation in the form of mode II shear microcracks<sup>1,2</sup>, mostly limited to a shallow depth of  $<0.005$  in ( $<125$   $\mu\text{m}$ ). The surface damage is a function of the contact conditions such as normal load, amplitude of slip, coefficient of friction and frequency. At certain point, the alternating stresses lead to mode I fatigue crack growth, propagating from the fretting-induced localized mode II shear microcracks<sup>3</sup>. Once this crack propagation stage is reached further fretting does not contribute to additional damage<sup>4</sup>, rather crack growth dominates the damage process. Several conferences<sup>5,6</sup>, a series of international fretting fatigue symposia<sup>7,8</sup> and review articles<sup>2,9,10,11,12,13,14,15</sup> on the subject have focused on the understanding of the contact mechanics and the specific mechanisms and fretting conditions that lead to failure. These earlier research have recently culminated in the creation of a new ASTM Standard E2789-10 for conducting fretting fatigue tests.<sup>16</sup> This standard recognizes that fretting fatigue is not a material response, rather it is a system response to a number of

factors including material, geometry of contact, method by which the loading and displacements are imposed, etc. In addition to terminology used in the context of fretting fatigue, this standard describes some methods of testing in broad terms.

More recently, the research interests have been on developing specific test methods simulating fretting conditions in real components<sup>17,18,19,20,21,22,23,24</sup> and the benefits of compressive residual stresses to mitigate mode I crack growth and failure from the fretting-induced mode II microcrack damage<sup>13,25,26,27,28,29,30,31,32,33,34,35,36,37,38</sup>.

In this review, an attempt is made to review different test methods and analyze results from some of the recent studies involving surface enhancement methods to mitigate fretting fatigue cracking in Ti-6Al-4V, the material that is most commonly used in turbine engine compressor. These blades and rotors are frequently affected by fretting fatigue damage on the contact face of the blade dovetail with the rotor disk posts. Figure 1 shows the sequence of fretting damage evolution leading to final failure in the rotor-blade dovetail contact faces. The edge of contact (Figure 1b) is the region of Maximum shear stresses<sup>39</sup>. Severe localized plastic deformation due to the maximum shear leads to the formation of slip bands at the EOC (Figure 1c). Continued deformation leads to the formation of mode II microcracks (Figure 1d), and these make the transition to mode I fatigue cracks (Figure 1e), leading to catastrophic failure. Most of the research focus has been on minimizing the EOC shear stresses through lubricants, coatings, etc., to mitigate mode II initiation of shear cracks. Recently, great strides have been made to mitigate mode I crack growth by introducing compressive residual stresses in the affected regions of the dovetail sections.

The goals of this review are to analyze, compare and summarize the results obtained through different fretting fatigue test methods in some of these studies, and to compare the beneficial effects of surface treatments like shot peening, low plasticity burnishing (LPB) and laser shock peening (LSP) to mitigate the mode I crack growth. Although the discussions in this review are limited to fretting fatigue of Ti-6Al-4V on Ti-6Al-4V parts, the general findings are broadly applicable to many other systems. The separation of these different stages of crack initiation, crack growth and final failure regardless of the mechanisms involved at each stage allows for mitigation of one of the stages to avert the catastrophic failure. The compressive residual stress technologies do not stop the fretting induced mode II shear crack initiation process. Complete mitigation of mode I crack growth and catastrophic failure is possible with the residual compression.

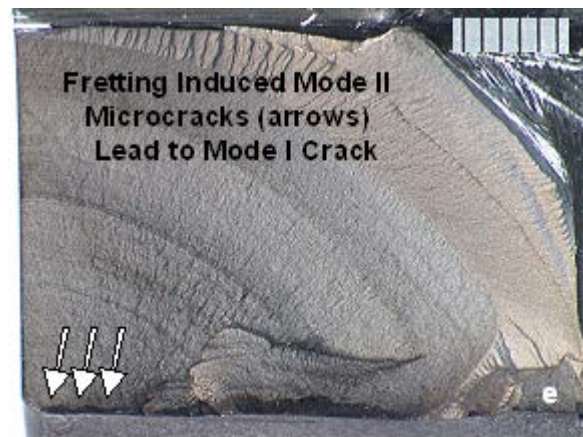
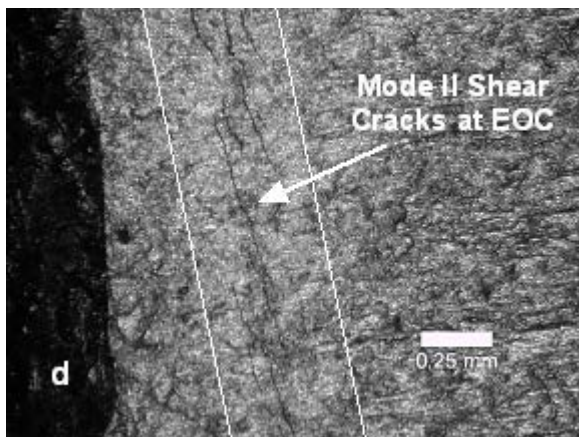
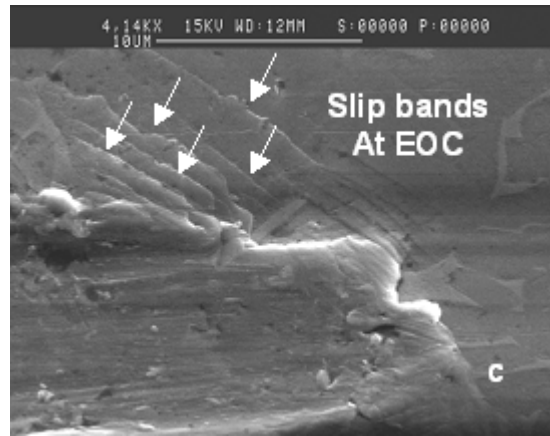
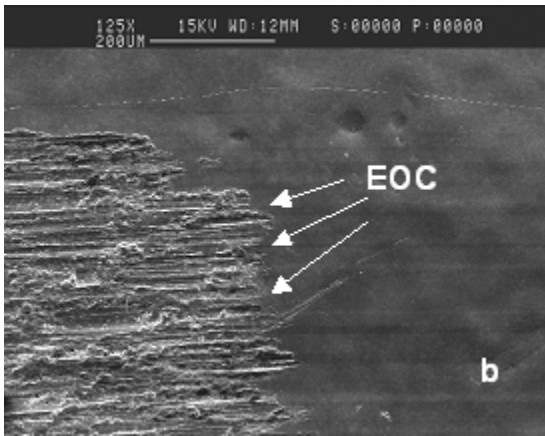
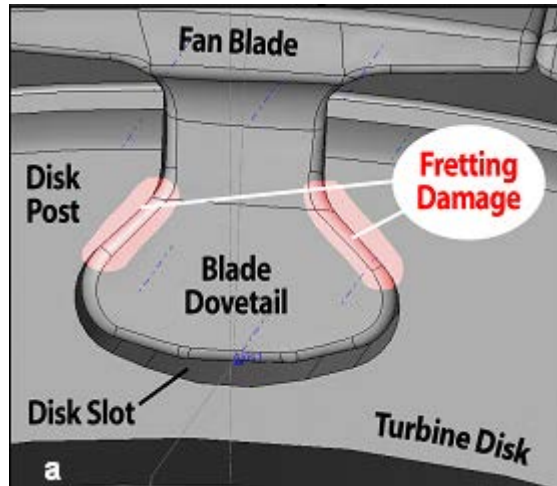

**Figure 1. Typical fretting fatigue damage sequence on the contact faces of the disk post and blade dovetail in a turbine engine. (a) Schematic of affected region, (b) EOC, (c) Formation of shear bands (arrows) at the EOC, (d) Formation of Mode II shear microcracks at the EOC, (e) Fractograph showing Mode I fatigue crack growth (seashell marks) emanating from the shear micro cracks (arrows).**

## REVIEW OF FRETTING FATIGUE TEST METHODS AND RESULTS:

Most of the earlier test methods were some variation of the conventional axially loaded fatigue flat “dogbone” specimen, contacted on both sides with cylindrical or short flat pads with blending radii at the edges of contact to induce fretting damage. Figures 2 and 3 show a typical test set up from Conner et al<sup>17,31</sup>. The typical contact and shear forces that are considered to be critical in the understanding of the evolution of fretting fatigue damage are shown schematically in Figure 4. In Figure 3 the axially loaded specimen surfaces are subjected to contact fretting with the use of pads. The normal forces on the pads can be adjusted, independent of the axial forces applied on the specimen, and a variety of test conditions can be examined. All the tests were conducted at a nominal  $R = S_{min}/S_{max} = -1$ . Indeed, in these studies, the authors investigated the effects of axial bulk stress ( $\sigma_b$ ), normal load ( $P$ ), and tangential load ( $Q$ ) in fretting of Ti-6Al-4V on Ti-6Al-4V. The results in Figure 5 show the effect of changing the tangential load on fatigue life. Evidently, increasing the tangential load from 15 to 30N increases the fretting damage. However, it is unclear if greater fretting damage is to be expected at even higher tangential load, and if there is a critical tangential load at which maximum fretting damage will happen.

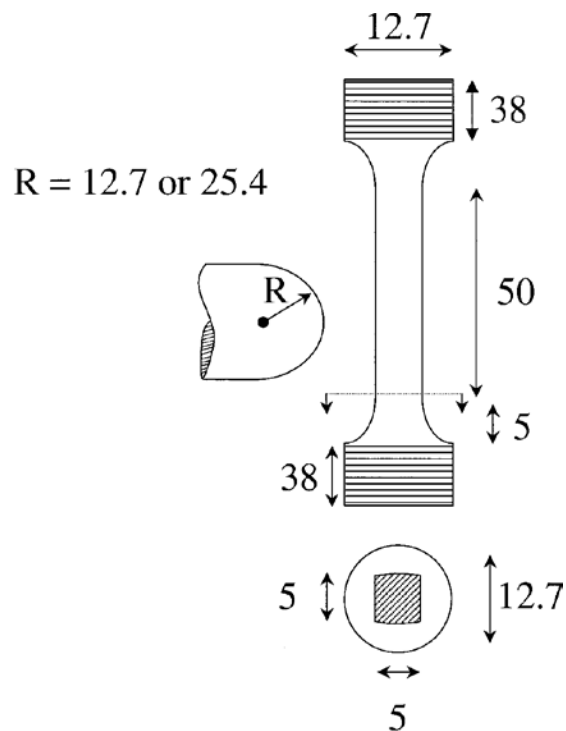

Figure 2 – Schematic of fretting fatigue sample and pad geometry. (all dimensions in millimeters, not to scale) (Conner et al 2001<sup>17,31</sup>)

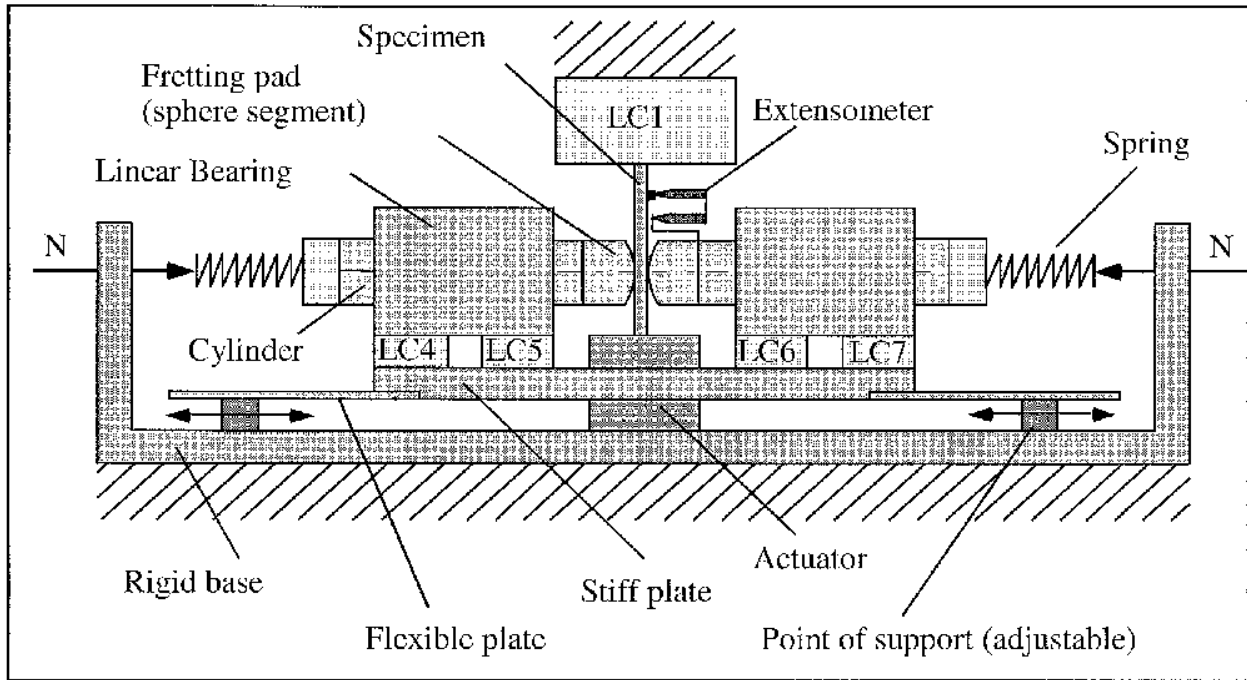

Figure 3 – Fretting fatigue test apparatus.[7] LC 5 load cell. (Conner et al 2001<sup>17,31</sup>)

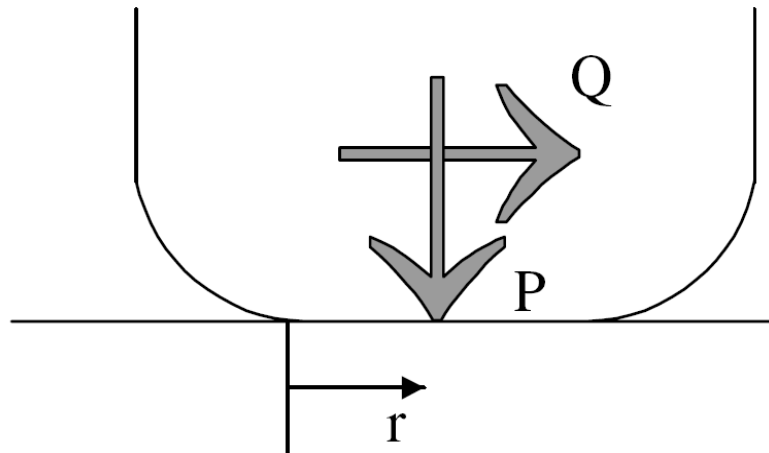

Figure 4 – Contact geometry and the forces contributing to fretting damage.<sup>15</sup>

Ti-6Al-4V Fretting Fatigue Data From Conner et al 2001  
Axially Loaded Specimen Geometry

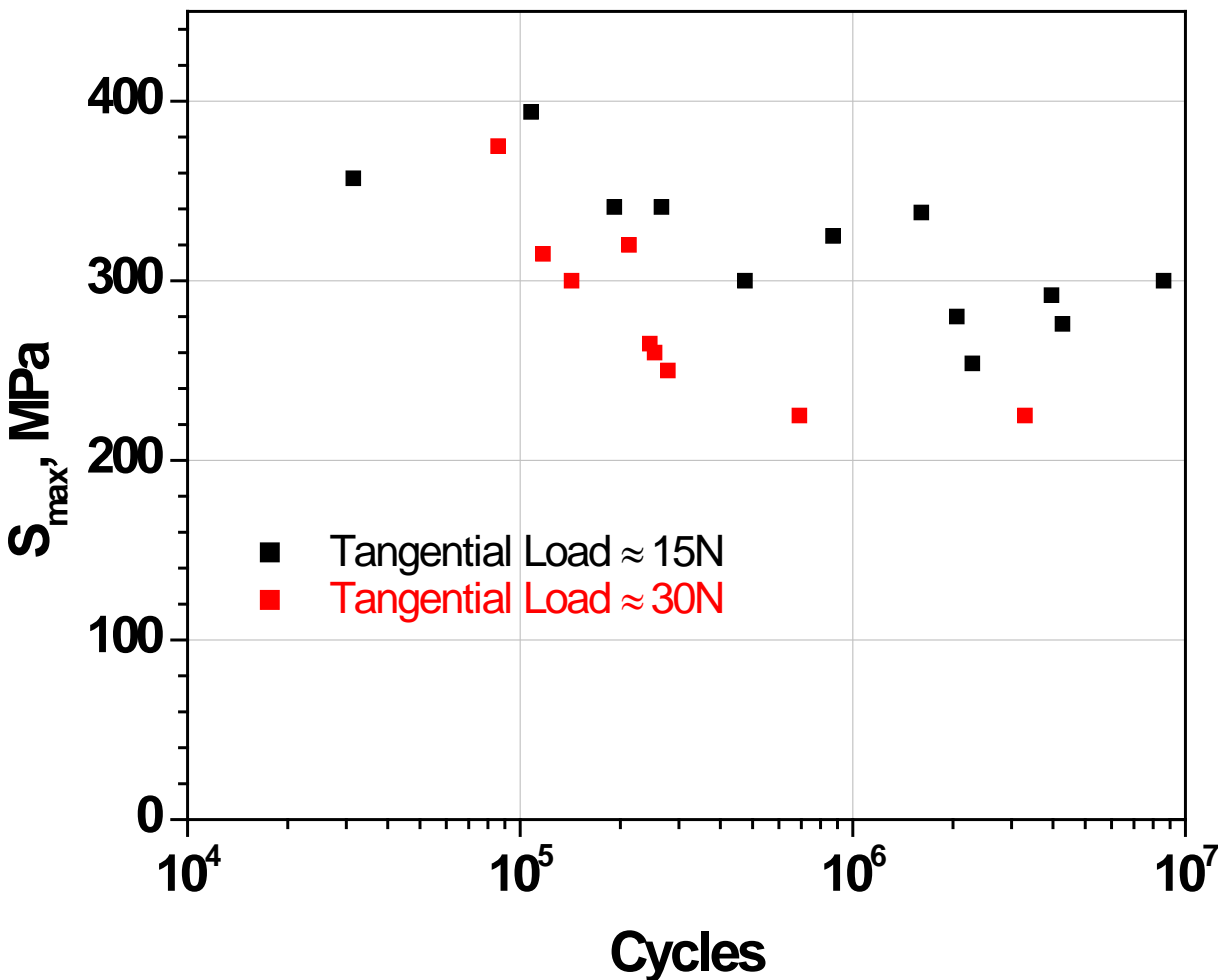

Figure 5 – Fretting fatigue test results from Conner et al<sup>17</sup> – axially loaded specimens with square cross section with transversely loaded fretting pads.

Neu et al<sup>15,19,20</sup> used a test setup shown in Figures 6 and 7. In the axially loaded fatigue specimen, they used four symmetrically placed contacts on the edge surfaces of the flat specimen. The results from this study for tests conducted at different  $R = S_{min}/S_{max}$  are shown in Figure 8. The pad geometry made little difference in the fretting fatigue life, at least at the stress ratio,  $R = -1$ . This effect was not studied at other stress ratios. The S-N data for other stress ratios, essentially followed the typical S-N response for any other type of damage, i.e., the allowable  $\sigma_{alt}$  at a given  $N_f$  is seen to increase with decreasing  $R$ . In this study, Neu et al conducted fretting fatigue tests with LPB as a surface treatment and the effects will be discussed in the next section.

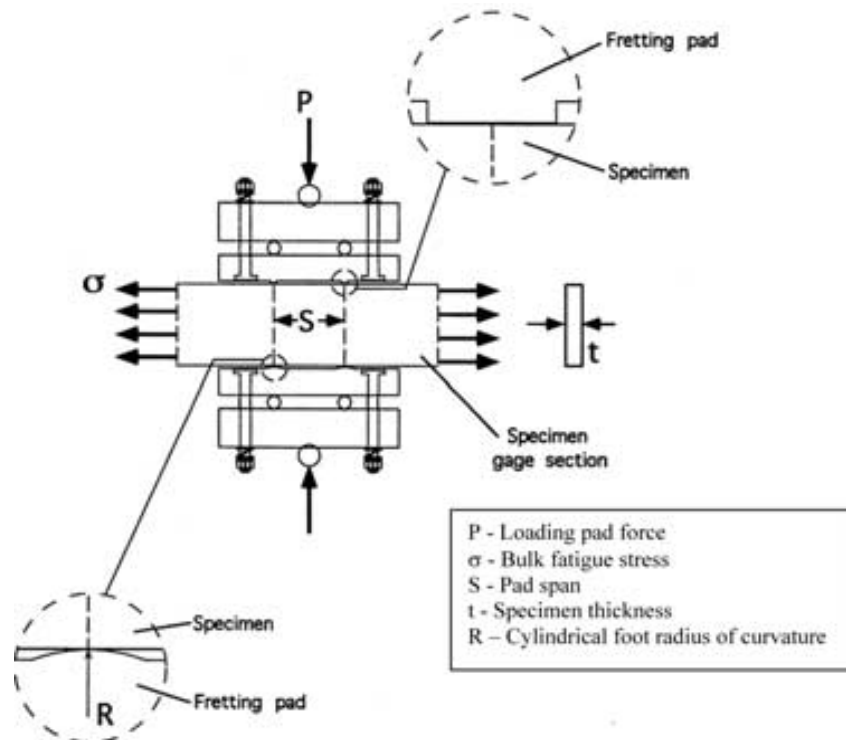

Figure 6 – Schematic of the Fretting Fatigue test Set up used by Neu et al.<sup>15,19,20</sup>

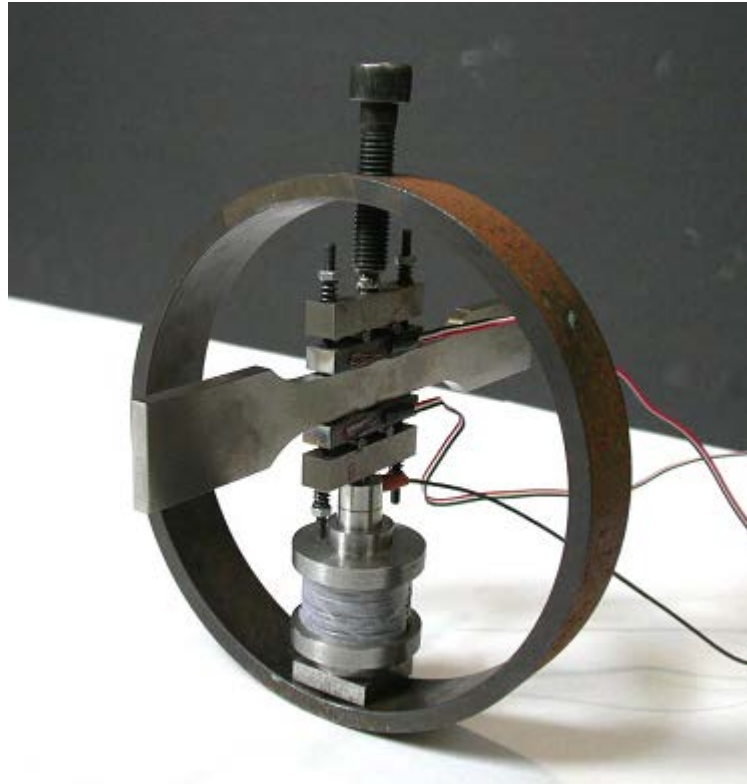
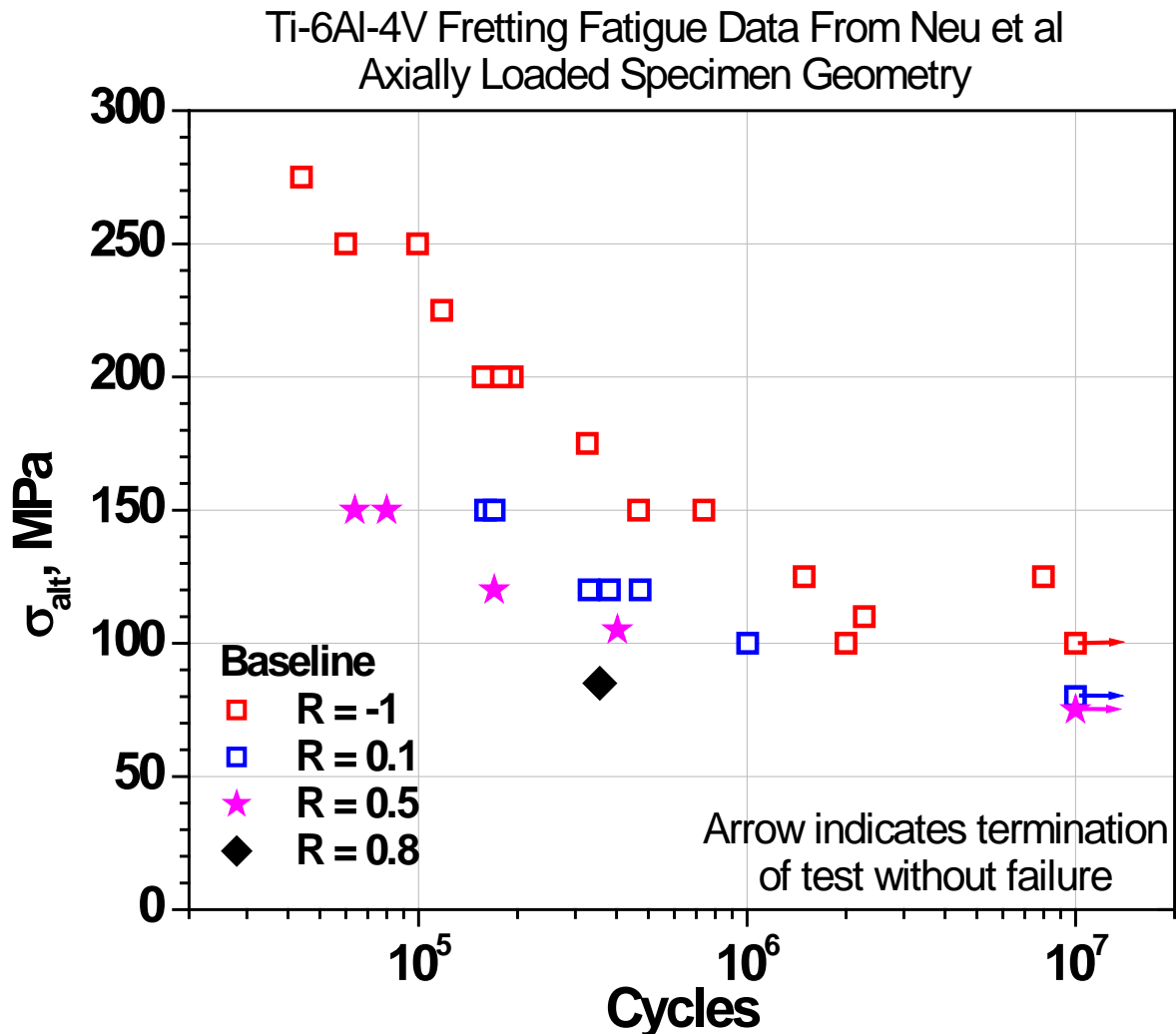

Figure 7 – Photo of the set up used by Neu et al.<sup>15,19,20</sup>



**Figure 8 – S-N data from fretting fatigue tests conducted by Neu et al<sup>15,19,20</sup> – axially loaded specimens with rectangular cross section with transversely loaded multiple fretting pads.**

Prevéy et al<sup>25</sup> used a 4-point bend fatigue apparatus that enabled the investigation of the relative effects of different surface treatments on fretting fatigue performance in materials, shown in Figure 9. Here, a specially designed specimen with a trapezoidal cross section is subjected to 4-point bending, and the maximum applied tensile stresses are realized on the top surface of the specimen with a gradient towards the neutral axis. The trapezoidal cross-section forces failure from the top face of the specimen even in the specimens with surface enhancement treatment like LPB or shot peening. A pair of fretting rods in a “bridge” configuration is pressed against the sample surface by an instrumented proving ring, which allows the adjustment, and monitoring of the force applied on the fretting rods. Preliminary trials were conducted to determine the optimum forces on the fretting rods that would produce the most serious fretting debit in fatigue performance. Since the focus of these studies were on the mitigation of fretting fatigue



damage using various surface treatments, the clamping force was held constant, and the contact mechanics and other factors for this method of testing were not considered.

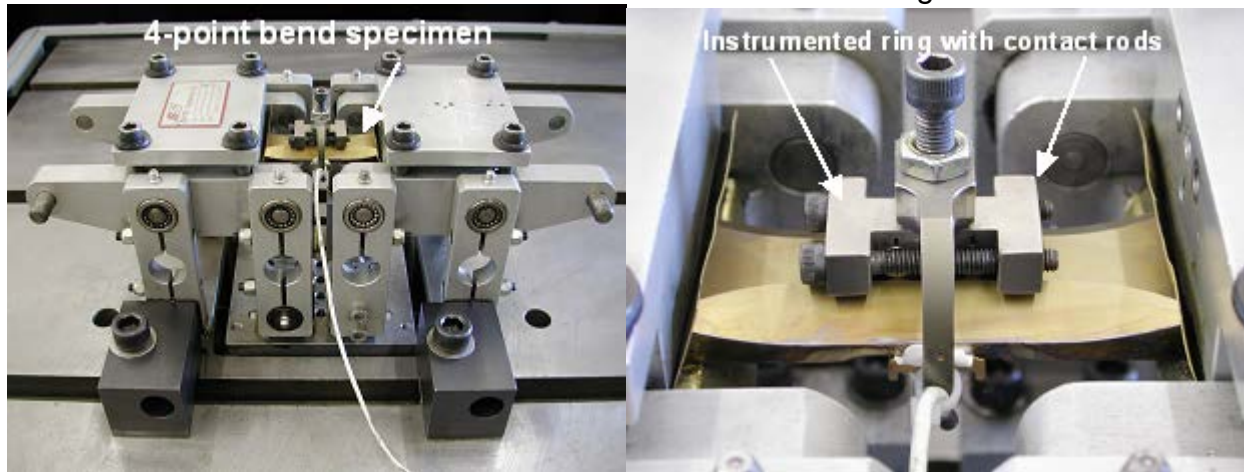
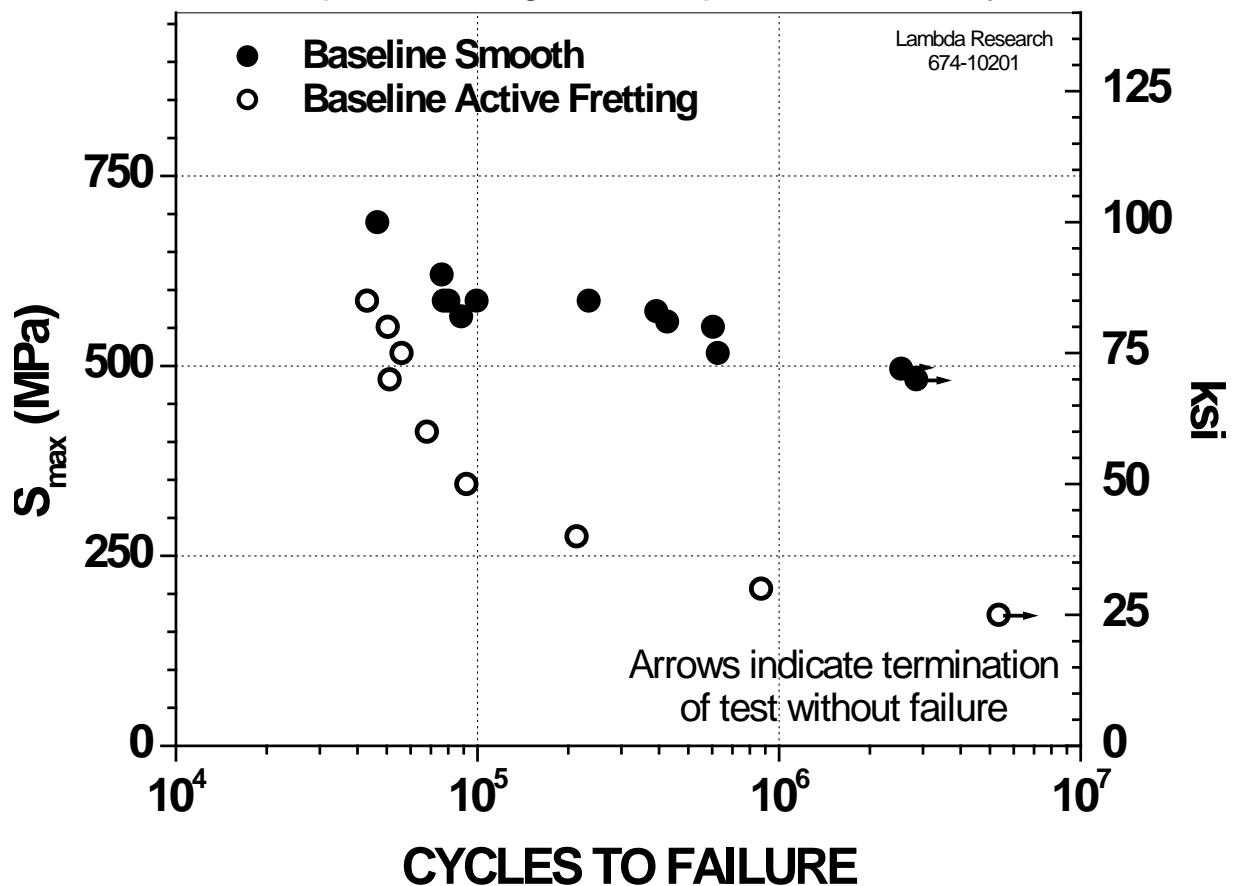

Figure 9 – HCF (4-point bending) testing set up with the fretting fixture mounted on the specimen used by Prev y et al<sup>25</sup> – full view of the test set up and a close-up view of the specimen.

Ti-6Al-4V Fretting Fatigue Data From Prevey et al  
4-point Bending Loaded Specimen Geometry



**Figure 10 – S-N data for the baseline condition from Prevéy et al<sup>25</sup> – four-point bending specimens with two fretting pads loaded normally to the tensile face.**

Figure 10 shows the S-N plot for the baseline (untreated) condition without and with fretting damage. The effects of fretting are evident in this plot.

Recognizing the geometry in fretting of turbine engine compressor blade dovetails, a number of researchers focused on simulating this geometry and loading in test methods, for example, Conner et al used a setup shown in Figure 11. As seen in the schematic shown in Figure 12, this geometry leads to very complex local contact forces and moments (both bending and torsional) that contribute to fretting at the edge of contact and fatigue cyclic stresses. A slight variation of the set up used by Conner et al<sup>21</sup> was used by Golden et al<sup>23</sup>, as shown in Figure 13. Golden et al conducted all their tests at  $R = S_{min}/S_{max} = 0.1$ , while Conner et al conducted a majority of their tests at  $R = 0.1$ . In addition to investigating test parameters like frequency,  $R$ , pad geometry, etc, these two groups also investigated the effects of surface treatments like LPB, laser shock peening (LSP), coatings, etc. The effects of surface treatment will be discussed in the next section. The fatigue performance for the baseline (untreated) condition in studies conducted by Conner shows a fatigue strength corresponding to a force of about 18 kN. Similarly, in Golden's studies, the baseline fatigue strength corresponded to a force of 16-18 kN.

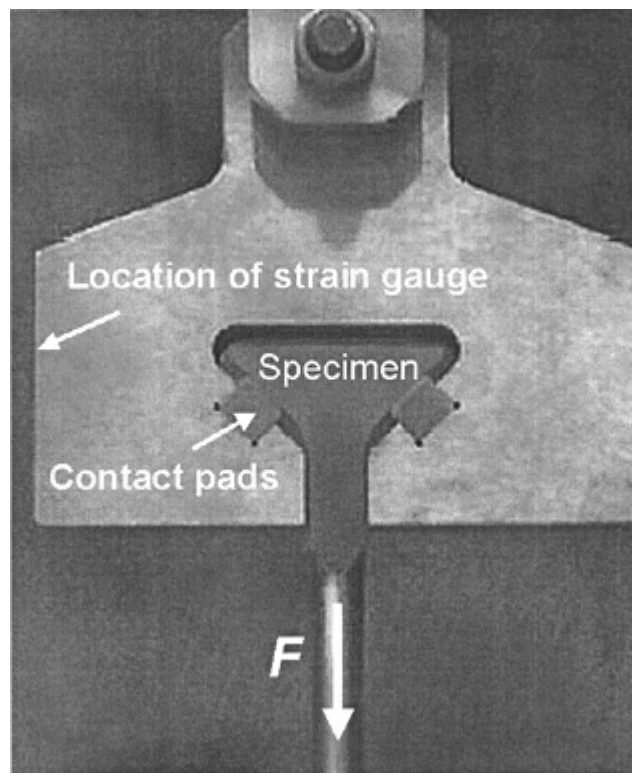

**Figure 11 – A photograph of the dovetail fixture with specimen and contact pads. (Conner et al 2006)<sup>21</sup>**

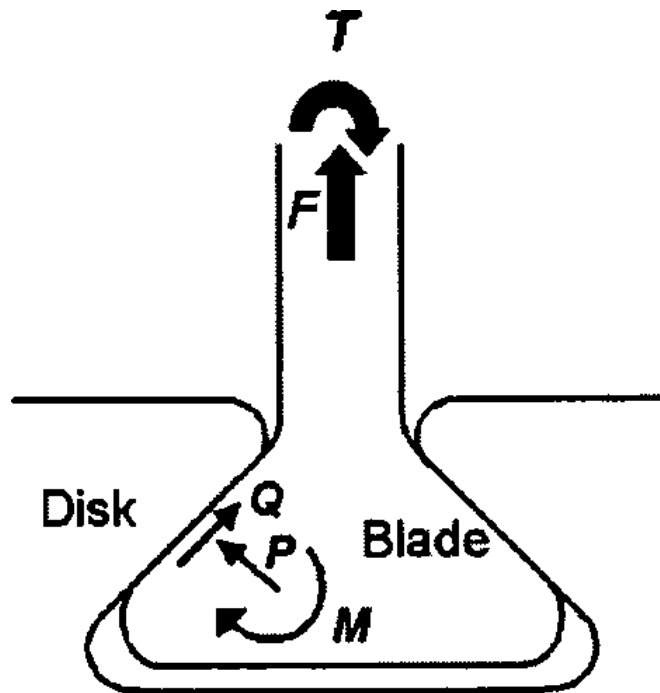

Figure 12 – A schematic of a blade-disk dovetail attachment in an aeroengine.<sup>21</sup>

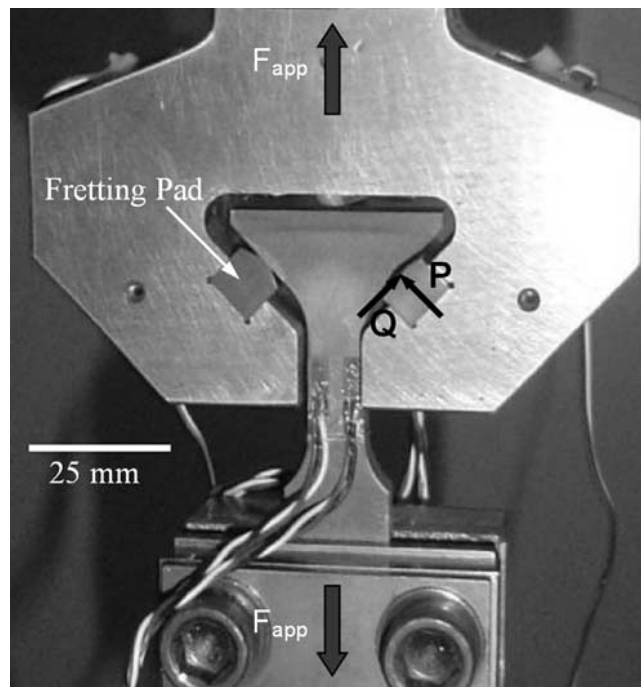

Figure 13 – Photograph of the dovetail fretting fatigue setup – Golden et al.<sup>23</sup>

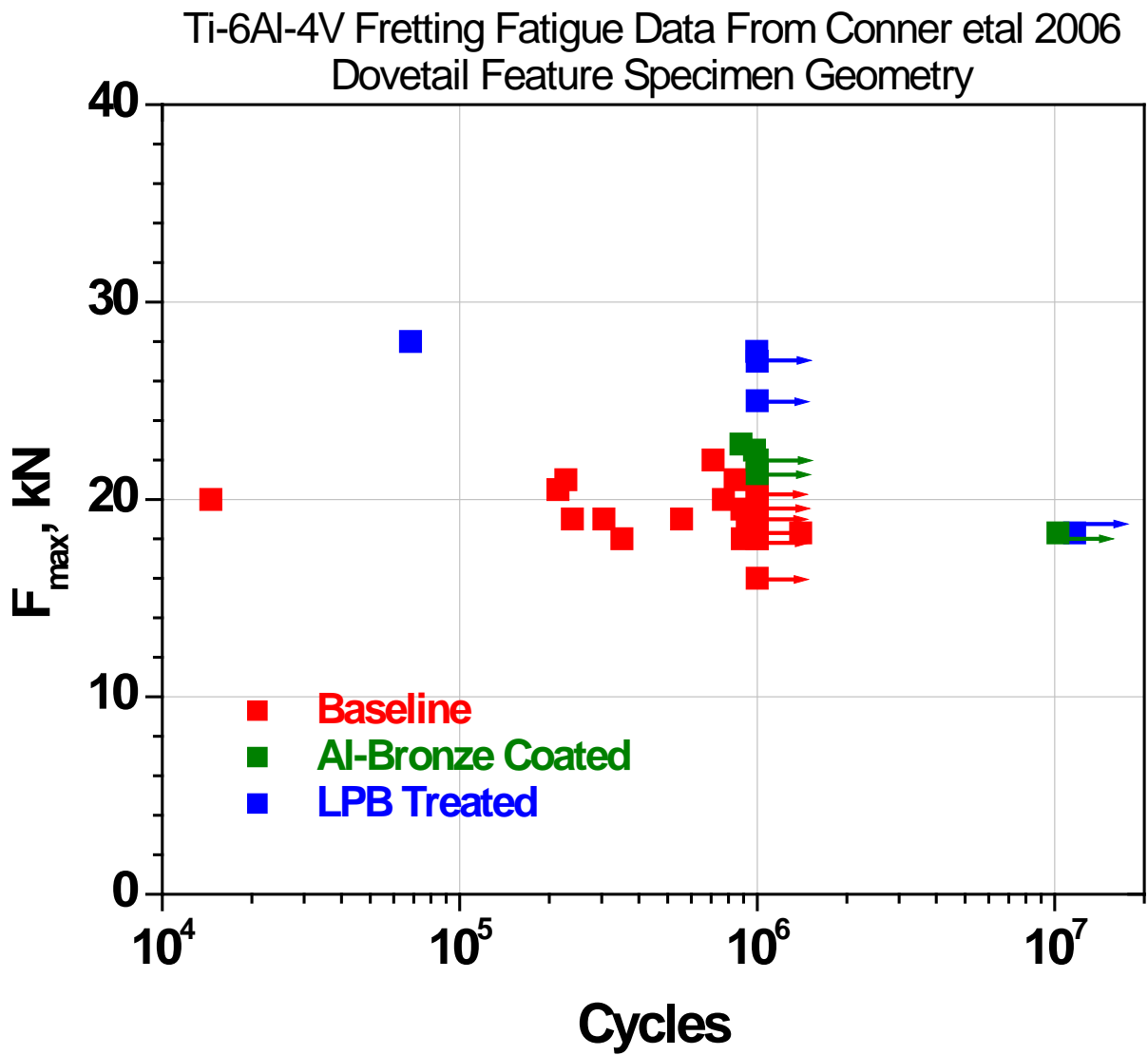

Figure 14 – Plot of fretting fatigue test results from Conner et al<sup>21</sup> – specimens with dovetail features.

Ti-6Al-4V Fretting Fatigue Data From Golden et al  
Dovetail Feature Specimen Geometry

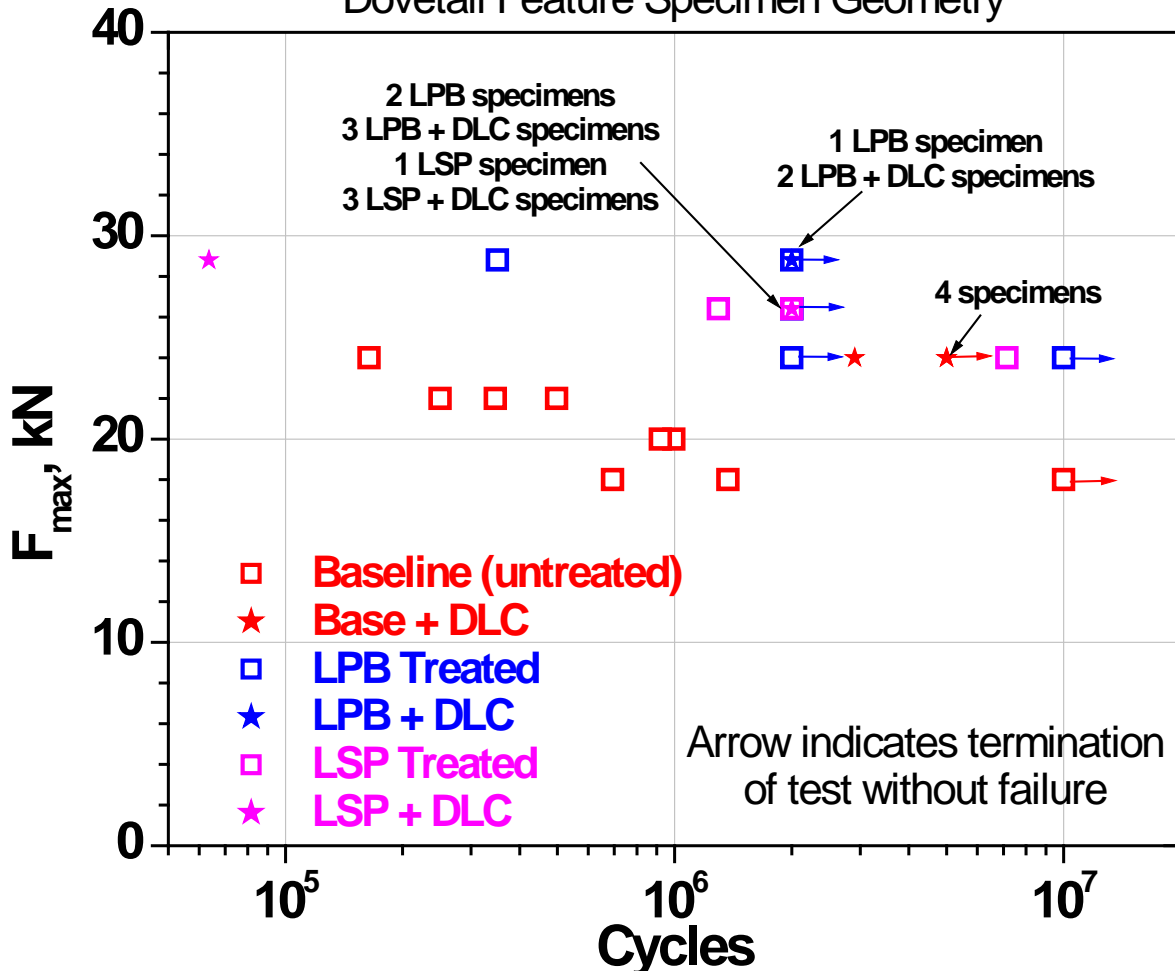

Figure 15 – Fretting fatigue data from Golden et al<sup>33</sup>– specimens with dovetail features.

**EFFECTS OF FRETTING GEOMETRY:**

Figure 16, provides an interesting comparison of results from test methods used by Neu et al and Conner et al. Considering the fact that both groups ran the tests in similar axial loaded conditions with fretting damage on the specimen surface through similar pads, the differences in the responses are evident. As indicated earlier, the fretting tangential loads applied in Conner et al work may have led to a less severe damage condition, compared to the conditions in the tests by Neu et al. It is also quite possible that this could be explained by the differences in the interactions between the fretting pad and the base specimen or in the microstructure of the material.

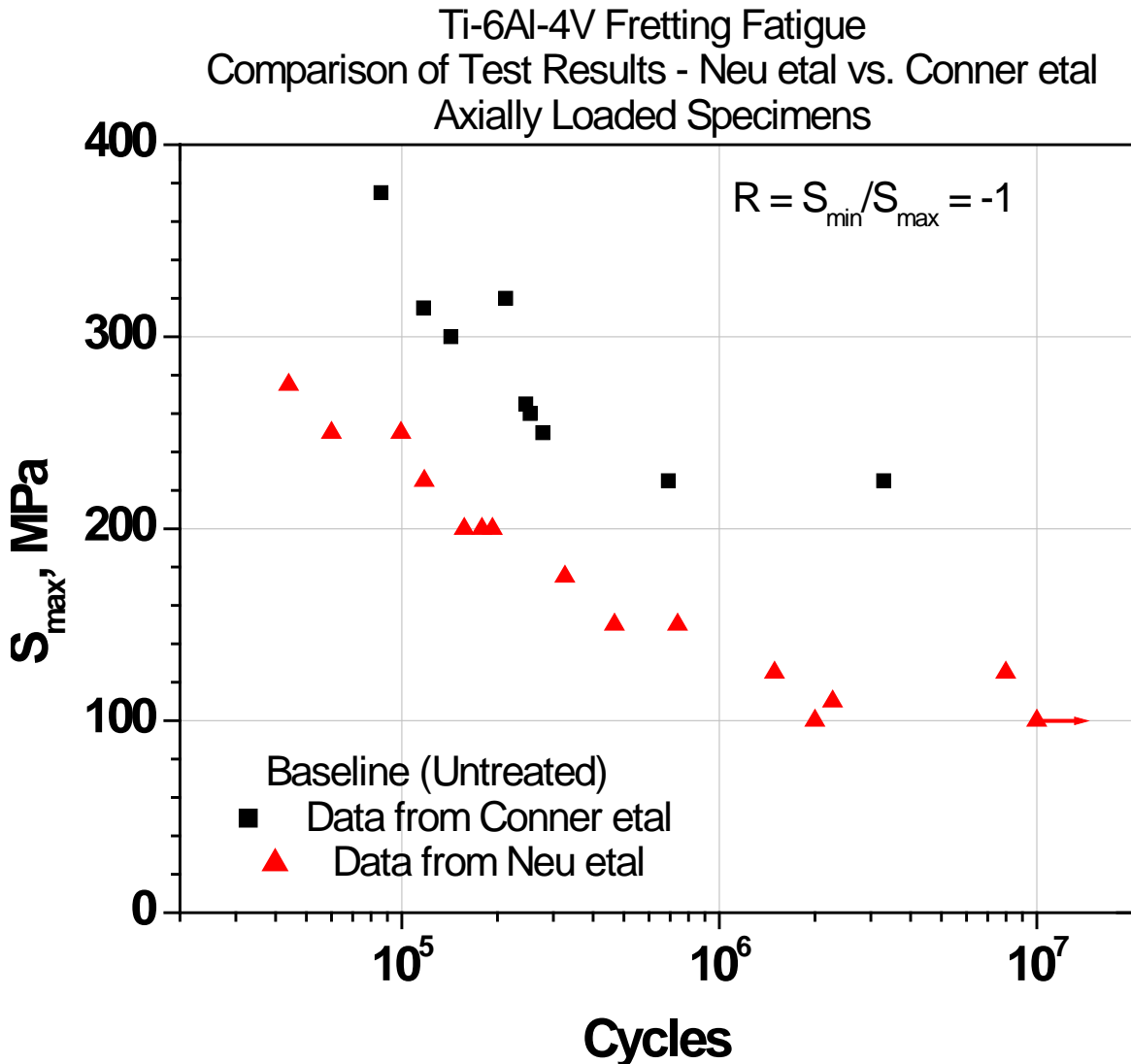

Figure 16 – Comparison of results from fretting axial fatigue tests conducted by Neu et al<sup>15,19,20</sup> and Conner et al<sup>17,31</sup> at  $R = -1$ .

Figure 17 shows a comparison of test results from the axial fretting fatigue tests conducted by Neu et al and the 4-point bending fatigue tests conducted by Prev y et al. It is interesting to note that in spite of the differences in the test methods the correlation between the test results are remarkable.

A similar comparison of test results from dovetail simulation specimens used by Conner et al and Golden et al shown in Figure 18 indicates that there is significant correspondence between these results. Since the test conditions were nearly identical between these two studies, it is not surprising to see such correlation.

The comparisons shown in Figures 16 through 18 may warrant additional analyses to determine if the correlation is real or fortuitous, and more importantly if such analyses are relevant when viewed in the context of pursuing a solution to the fretting fatigue problem, rather than studying the problem.

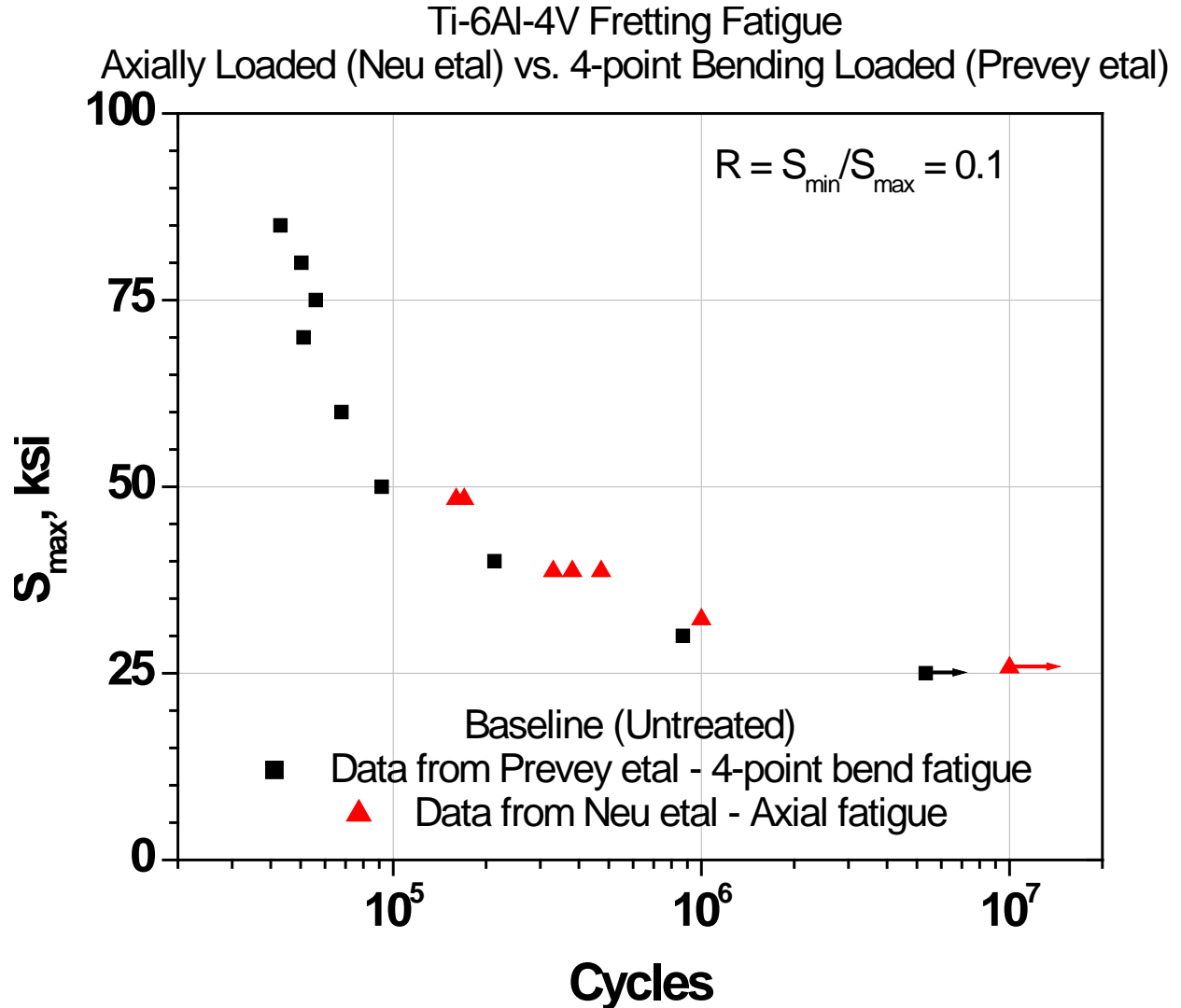
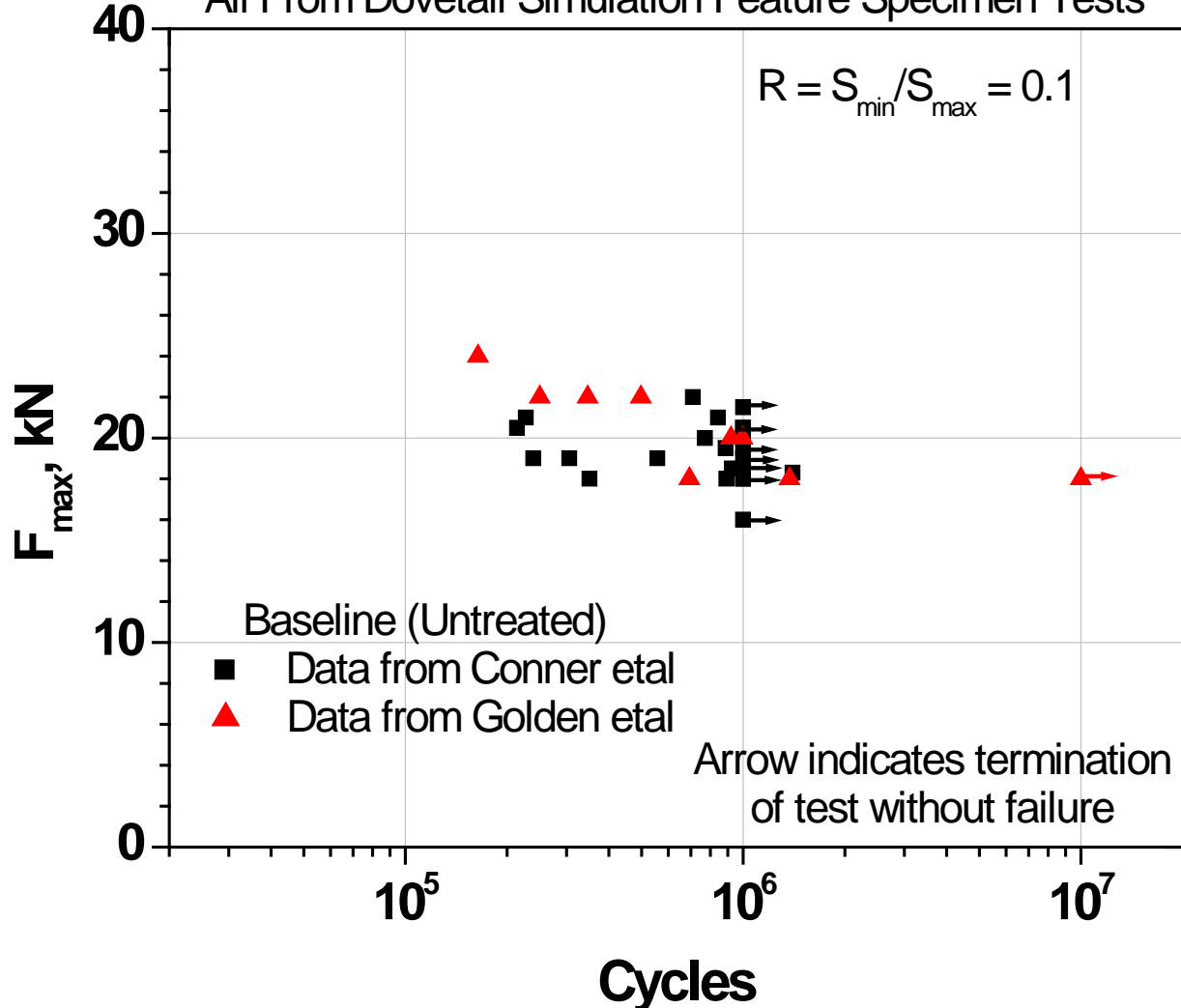

Figure 17 – Comparison of fretting fatigue test results from Neu et al<sup>15,19,20</sup> and Prev y et al.<sup>25</sup>

**Ti-6Al-4V Fretting Fatigue**  
**Comparison of Test Results - Golden et al vs. Conner et al**  
**All From Dovetail Simulation Feature Specimen Tests**



**Figure 18 – Comparison of test results for the baseline (untreated) condition for dovetail simulation data,  $R = 0.1$ , from Conner et al<sup>21</sup> and Golden et al.<sup>33</sup>**

The results from these various studies indicate that there is substantial agreement and consistency between the various methods of testing. More importantly, it appears that the material/component behavior is affected by the local stress state more than the way the stress is applied. That is, axial, bending, or combined stresses all can lead to a tensile stress component in a region. When this region is subjected to contact-induced shear at the edge contact, it will lead to similar debit in fatigue performance. There is also no significant effect of frequency on the test results, all conducted at room temperature. Further, use of any of these test methods to interrogate the effects of surface treatments to mitigate the fretting damage will yield consistent results.



## **EFFECT OF SURFACE TREATMENTS ON FRETTING FATIGUE LIFE:**

Several different studies have been conducted on the effects of surface treatments to introduce compressive residual stresses to mitigate fretting fatigue damage with varying degrees of success. Figure 18 shows a photograph of an LPB treated test specimen used in the studies by Neu et al<sup>26</sup>. The polished looking LPB zone in the gage section of the specimen is evident in this figure. Similarly, Figure 19 shows the LPB treated zone near the contact regions of the dovetail simulation specimen used in the studies by Conner<sup>21</sup>. One important distinction in LPB treatment is that unlike shot peening, which is often applied uniformly all over the surface of a component, LPB is applied only in the local affected regions with the fretting or any other damage. In actual components (and in these specimens) the residual stress distribution and the entire LPB operation is specifically designed to mitigate the damage in the applied stress field.



**Figure 18 – A photograph of a LPB treated axial specimen. Notice the polished appearance of the specimen in the gage section. (Neu et al 2006<sup>26</sup>)**

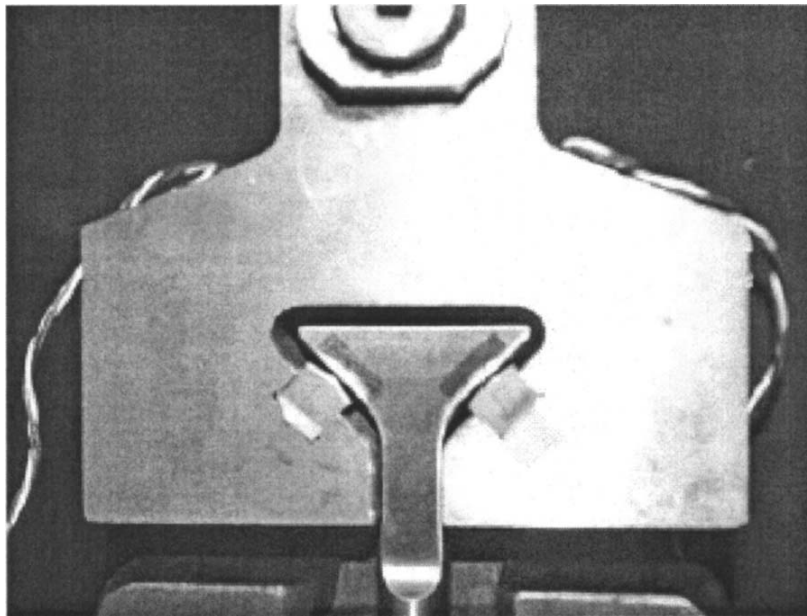

**Figure 19 – A photograph of a LPB treated specimen in the dovetail fixture. Notice the polished appearance of the specimen regions near the contact pad. (Conner et al 2006<sup>21</sup>)**

Figure 20 is a S-N plot of the fatigue test results from Neu et al showing the benefits of LPB on axial specimens subjected to fretting fatigue. There is over a 100x improvement in fatigue life, depending on the applied stresses, and over a 2x improvement in fatigue strength. It is important to note that the two specimens that failed in this group of LPB treated specimens both failed outside the LPB zone. Therefore, the actual improvement in fatigue performance with LPB is greater than indicated. The importance of proper specimen design to interrogate the effectiveness of this type of technology is also indicated. This observation is repeated in almost all of the other studies.

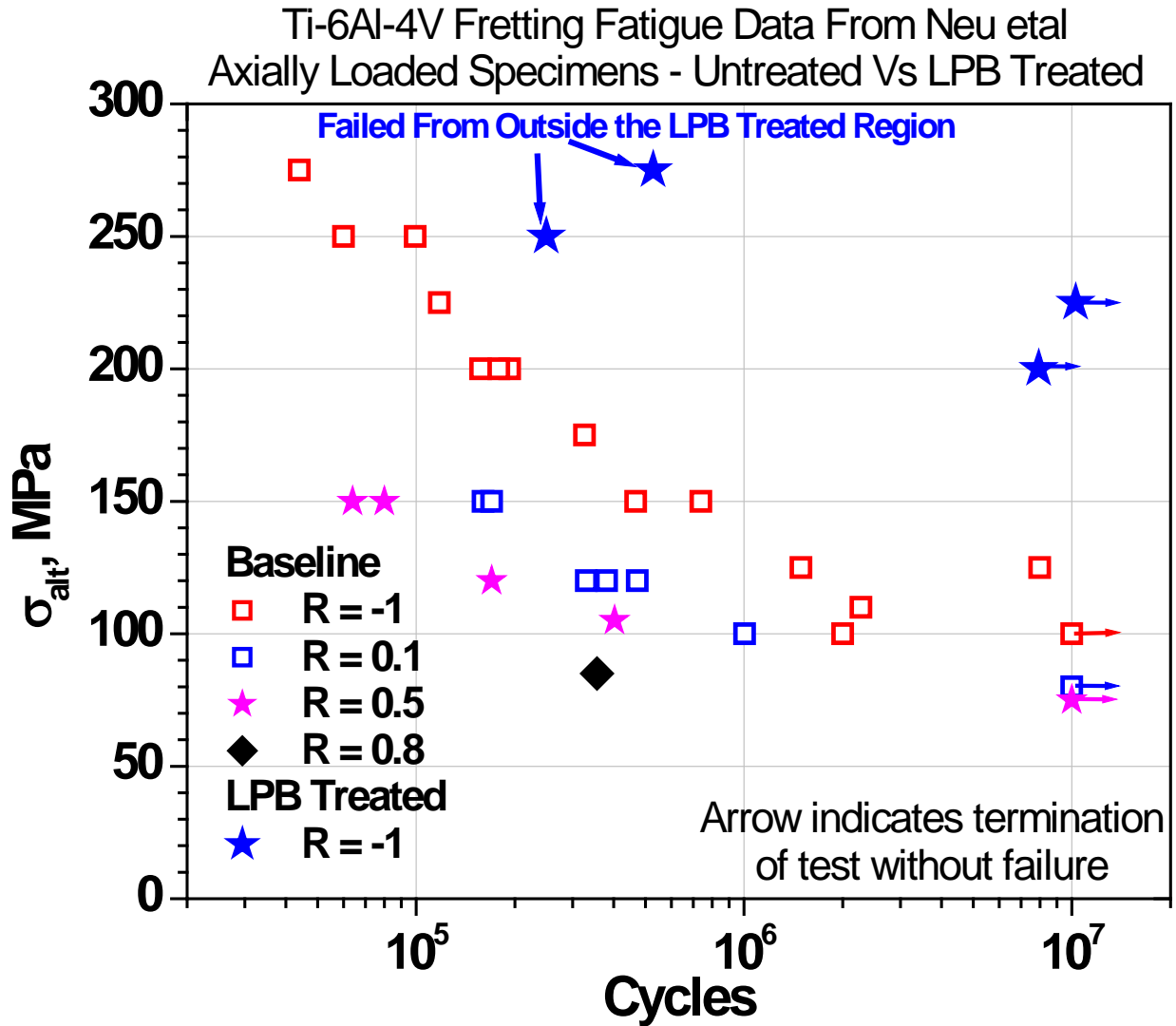

Figure 20 – Fatigue test data from Neu et al<sup>15,19,20</sup> showing the benefits of LPB, both in improved life and in improved fretting fatigue strength, of Ti-6Al-4V. Note that the LPB benefit is greater than indicated because failure did not occur within the LPB zone.

The comprehensive work of Prev y et al<sup>25</sup>, shown in Figures 9, 21, 22 and 23, clearly brings out the relative benefits of shot peening and LPB treatment to mitigate fretting fatigue damage. In this early study from 2003, again all the LPB treated specimens tested at stresses below about 100 ksi did not fail from crack initiation at fret marks. However, it is important to note that >100x and >20x improvement in life is seen for LPB treated specimens compared to the baseline (untreated) and shot peened specimens, respectively.

The results from Conner et al in Figure 13 show the relative benefits of Al-bronze coating and LPB treatment to mitigate the fretting fatigue damage in dovetail feature specimens. The slight improvement in performance for the Al-bronze coating is evident, but the substantial benefits of LPB treatment to mitigate fretting fatigue damage is unmistakable in this plot. Again, the LPB treated specimens in this study did not fail from the fretting damage, rather by overload in other parts of the specimen.

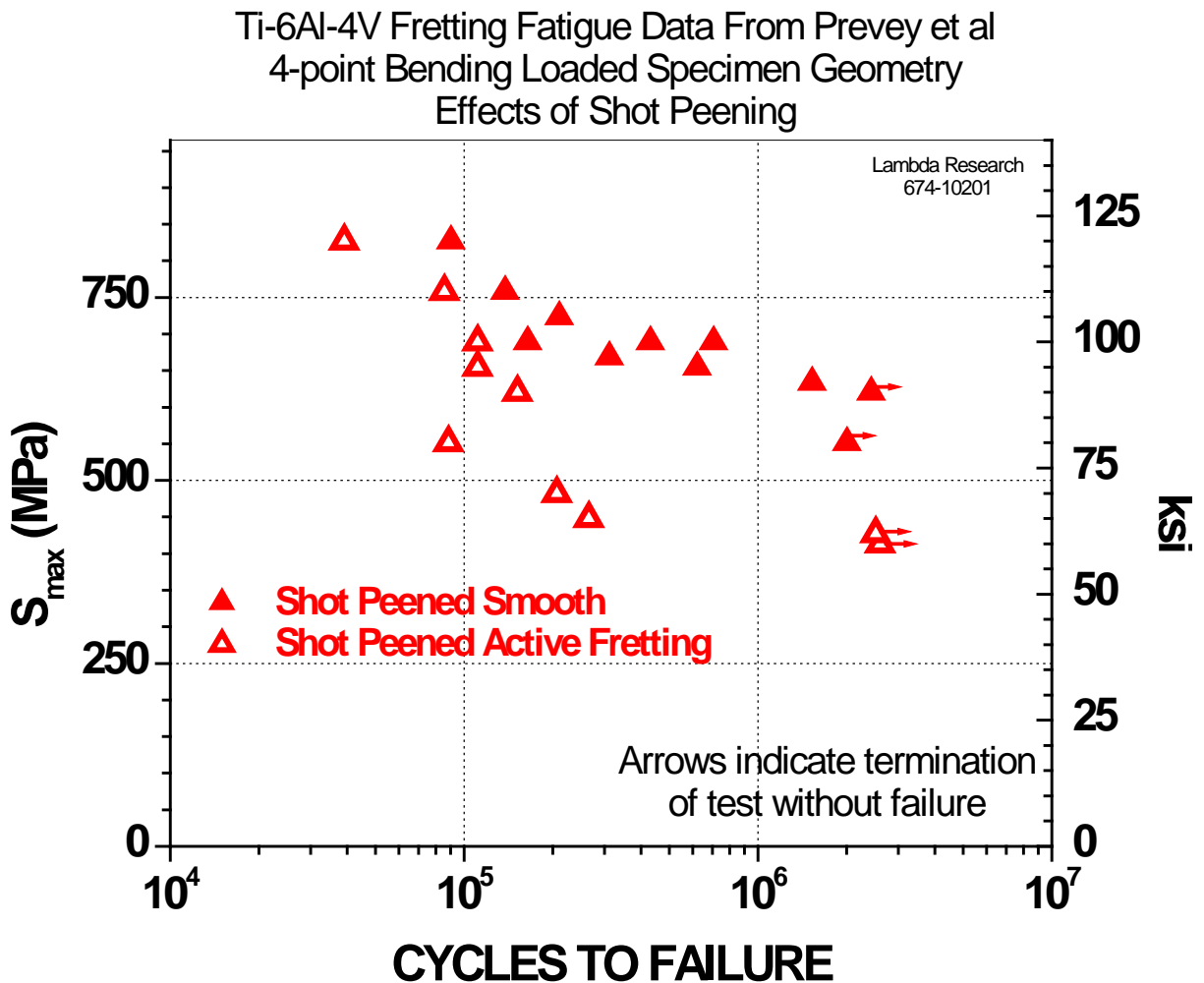

Figure 21 – Fatigue test results for shot peened Ti-6Al-4V specimens from Prev y et al.<sup>25</sup>

Ti-6Al-4V Fretting Fatigue Data From Prevey et al  
 4-point Bending Loaded Specimen Geometry  
 Effects of LPB Treatment

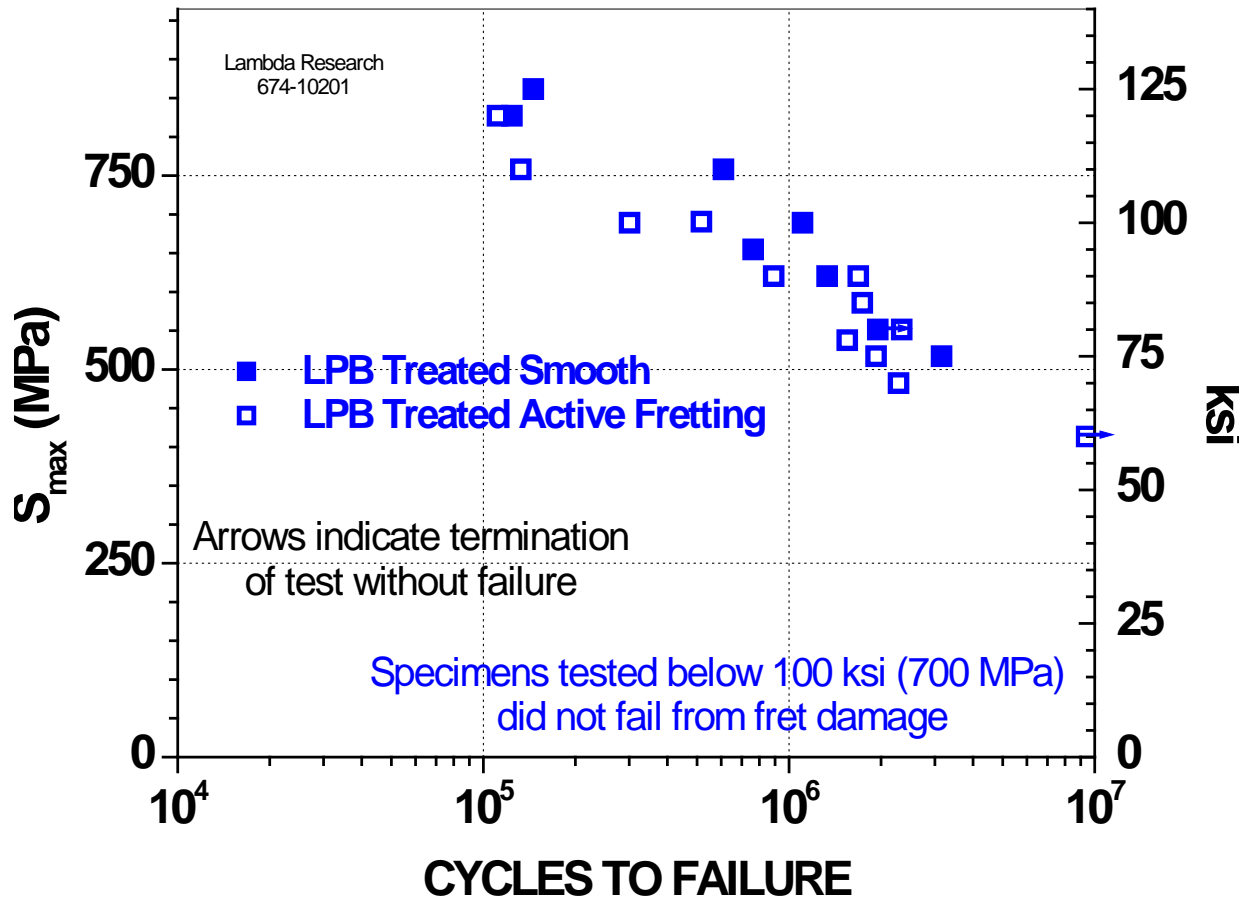

Figure 22 – Fatigue test results for LPB treated Ti-6Al-4V specimens from Prevéy et al.<sup>25</sup>

Golden et al also conducted comprehensive studies comparing the performance of dovetail feature specimens with DLC (diamond like coatings), LSP treatment and LPB treatment under fretting fatigue conditions. In their conclusions, although the authors grouped both the LPB and LSP treated specimens to show similar benefits, it is quite evident from Figure 14 that the LPB treated specimens (without and with DLC coatings) clearly outperformed specimens with all other treatments. There is a >10x improvement in life for LPB treated specimens over the LSP treated specimens tested at the highest load.

Ti-6Al-4V Fretting Fatigue Data From Prevey et al  
 4-point Bending Loaded Specimen Geometry  
 Effects of Shot Peening and LPB Treatment

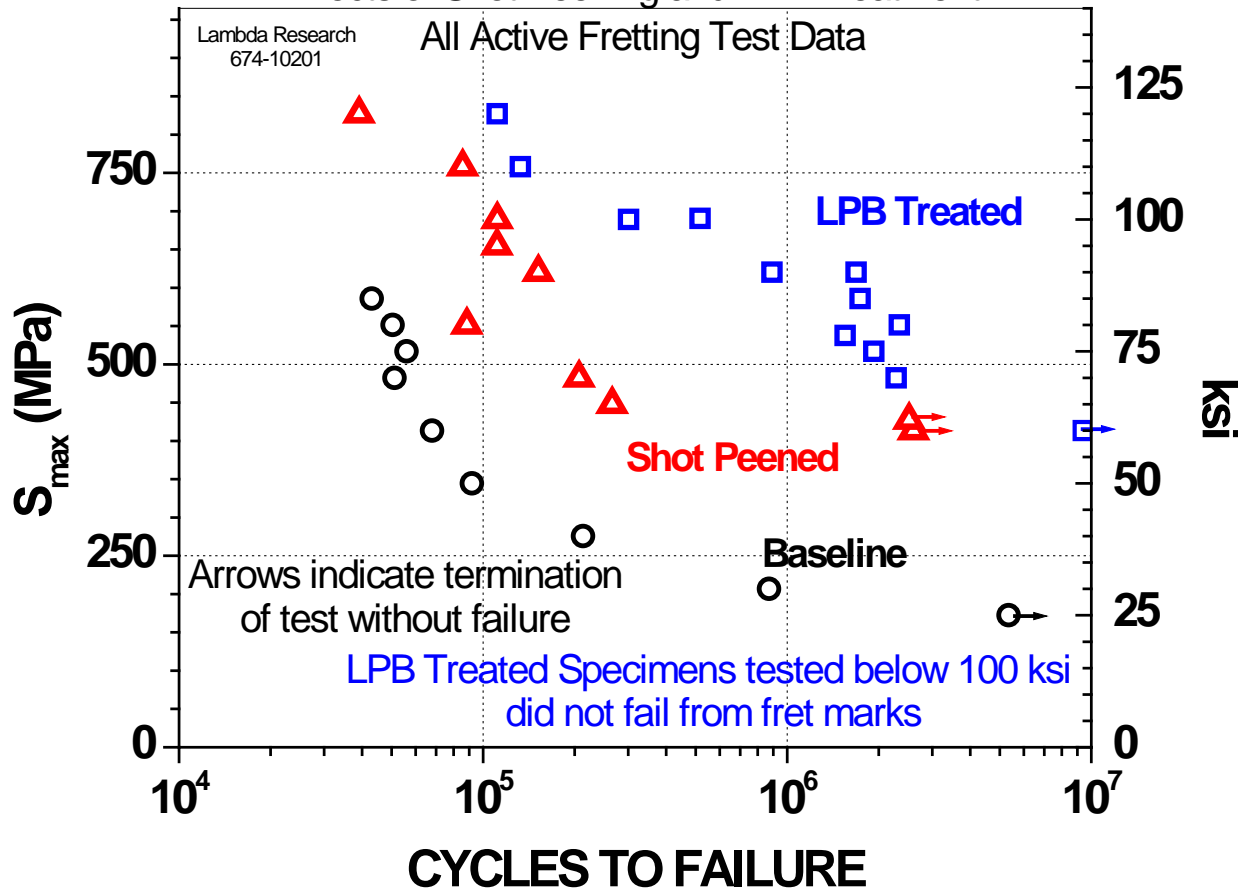

Figure 23 – Comparison of fatigue test results for baseline (untreated), shot peened and LPB treated Ti-6Al-4V specimens with fretting from Prevéy et al.<sup>25</sup>

**EFFECT OF SURFACE TREATMENTS ON FRETTING SCARS**

It is evident from the various studies of Prevey, Connors, Neu and Golden that compressive residual stresses introduced by LPB or LSP significantly mitigate failure from fretting fatigue. These studies have demonstrated that mode I crack growth can be completely shut down by the compression. It is important to note that fretting damage in the form of fretting scars or the deformation at the edge of contact is not affected by the compressive residual stresses. Although a systematic study including all the variables like the forces on the fretting pads (like  $P_{normal}$ ,  $Q$ , etc.) was not conducted, a review of a comparison of the size of the fretting scars for the LPB treated surfaces vs the baseline (untreated) surfaces in Prevey et al's research is in order. Figures 24 and 25 show typical fret marks from a baseline untreated specimen and an LPB treated specimen. Fret marks in shot peened specimens were not clearly visible due to the rough surface finish in those specimens. Figure 26 shows a comprehensive plot of the

effect of surface treatment and applied stresses on the width of the fret marks. Generally, the LPB treated surfaces show wider fret scars compared to the untreated surfaces. This is attributed to the smooth surface finish and higher fatigue stresses for these specimens. However, the scar size appears to have very little influence on the total fatigue lives. As seen in Figures 10 and 21 to 23, LPB specimens clearly outperformed the baseline untreated specimens. One must conclude that the compressive residual stress had little influence on the development of fretting damage, but had a significantly beneficial effect on preventing the propagation of cracks. This is the primary focus of the component studies presented in the following section.

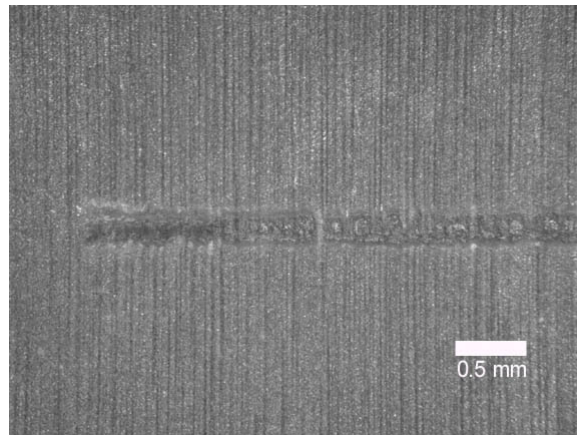

Figure 24. Typical fretting fatigue scar on baseline untreated Ti-6Al-4V specimen surface ( $S_{max}=35$  ksi and  $N_f=427,787$  cycles)

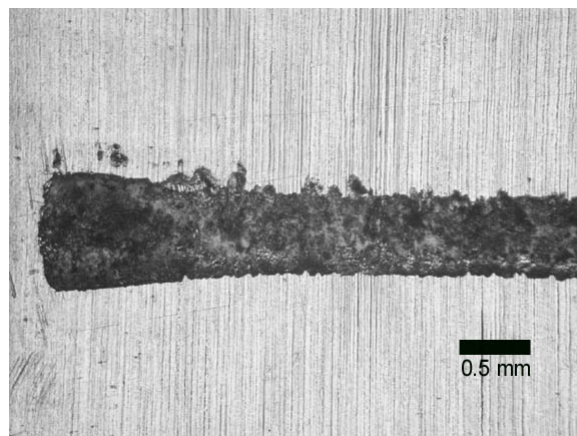

Figure 25. Typical fretting scar on LPB treated Ti-6Al-4V specimen surface. ( $S_{max}=78$  ksi and  $N_f=1,550,922$  cycles)

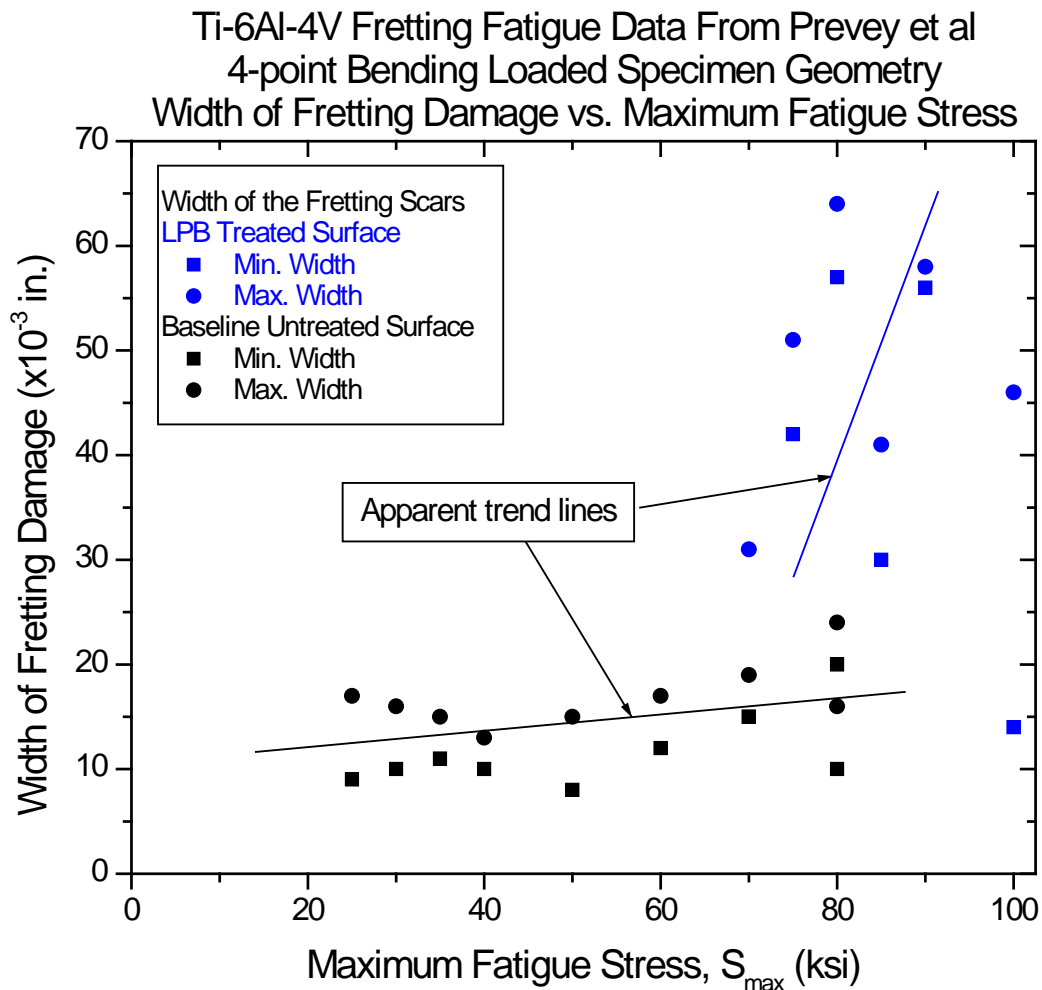
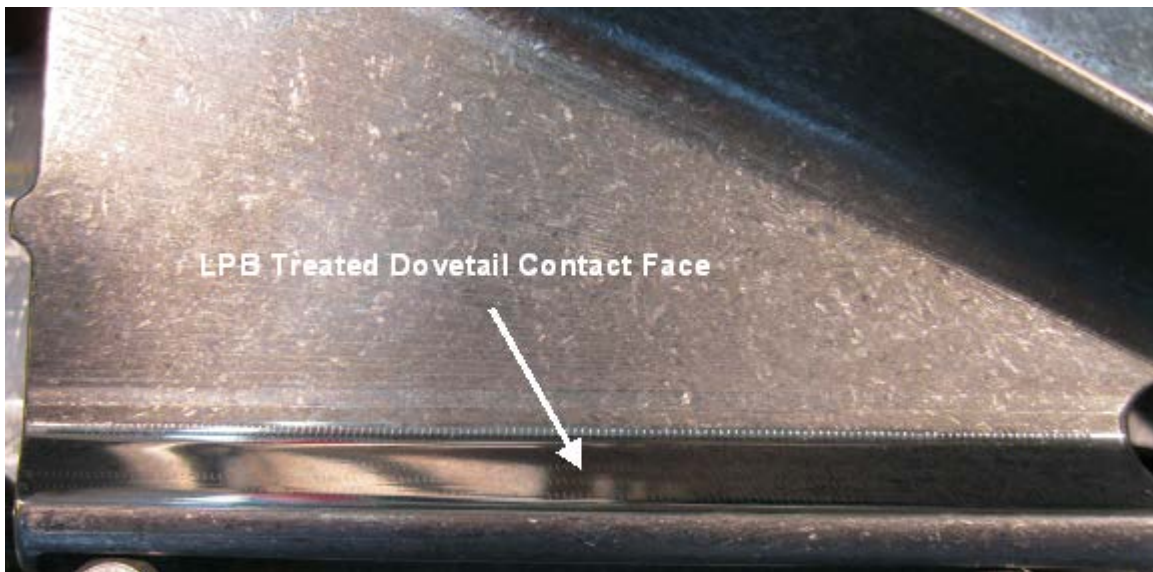

Figure 26. Plot of Fretting Scar Size as a function of Maximum Fatigue Stress.

### COMPONENT STUDIES:

Several studies have been conducted over the last decade to mitigate fretting fatigue damage in F402 Stage 1 compressor blade dovetail contact faces, F402 Stage 1 rotor post contact faces, and contact faces in F404 Stage 1 compressor blades. Publications representative of these works are given in references 40,41,42. In each of these cases, the residual stress design was done using the FDD (fatigue design diagram) method<sup>43</sup> and other linear elastic fracture mechanics (LEFM) based lifing methods<sup>44</sup>. Appropriate LPB tools were used, and LPB design protocol was followed in the execution of these programs, details of which may be obtained from the cited reference. Full-scale component tests were conducted to verify the performance to fully mitigate simulated fretting fatigue damage.

Figure 24 shows the LPB treated dovetail contact face on a F404 Stage 1 compressor blade. Figure 25 shows the location, geometry and size of the simulated fretting damage in the form of an EDM notch at twice the maximum fretting induced microcrack depth located at the edge of contact. The location of this simulated damage is consistent with the damage seen in fielded blades, and the size is considered to be more aggressive than what is typically seen for fretting induced microcracks. While the fretting induced microcrack damage is limited to 0.003 to 0.005 in. deep from the surface, the simulated damage in the form of an EDM notch, as shown in Figure 25 is 0.010 in. deep. Figure 26 shows the typical fatigue test setup used at Lambda for component tests. A cantilever beam arrangement is used, and the maximum applied stress is at the location of the edge of contact in the dovetail section of the blade. Fatigue tests were conducted both on baseline (as-received) blades and LPB treated blades at an  $R = S_{min}/S_{max} = 0.5$ . This higher R was chosen in view of the fact that the dovetail sections experience a high mean stress associated with the centrifugal forces during the service of the aircraft engine. The as-received blades were previously shot peened per OEM specifications, and therefore had a shallow layer of compressive residual stresses. Comparison of test results for both the smooth and simulated damage conditions are shown in the form of a bar chart in Figure 27. As seen here, the fatigue performance of the LPB smooth condition shows that LPB did no harm over the baseline (as-received) condition. Indeed, with the simulated damage of 0.010 in. deep EDM notch, the fatigue performance was much better than the baseline (as-received) condition (an undamaged part).



**Figure 24 – Photo showing the LPB treated dovetail contact face on a F404 Stage 1 compressor blade.**



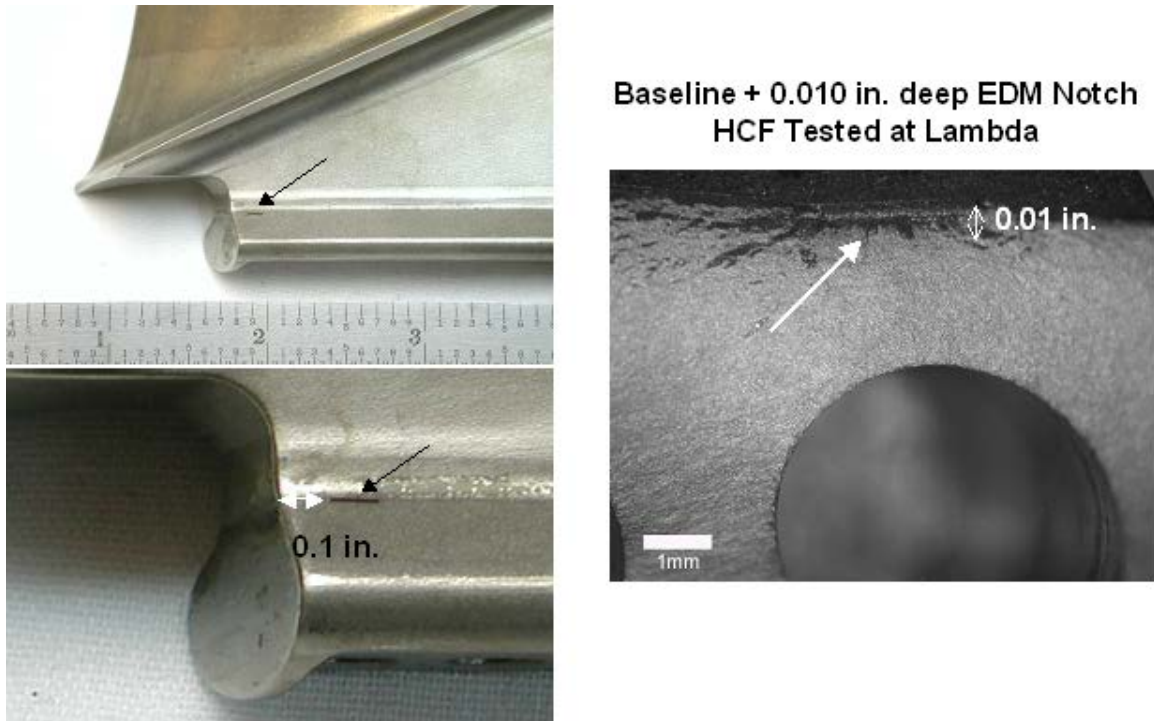

**Figure 25 – Location and dimension of an EDM notch simulating fretting fatigue damage at the edge of contact in the F404 blade dovetail contact face.**



**Figure 26 – Full scale fatigue test set up for the F404 Stage 1 compressor blade dovetail.**

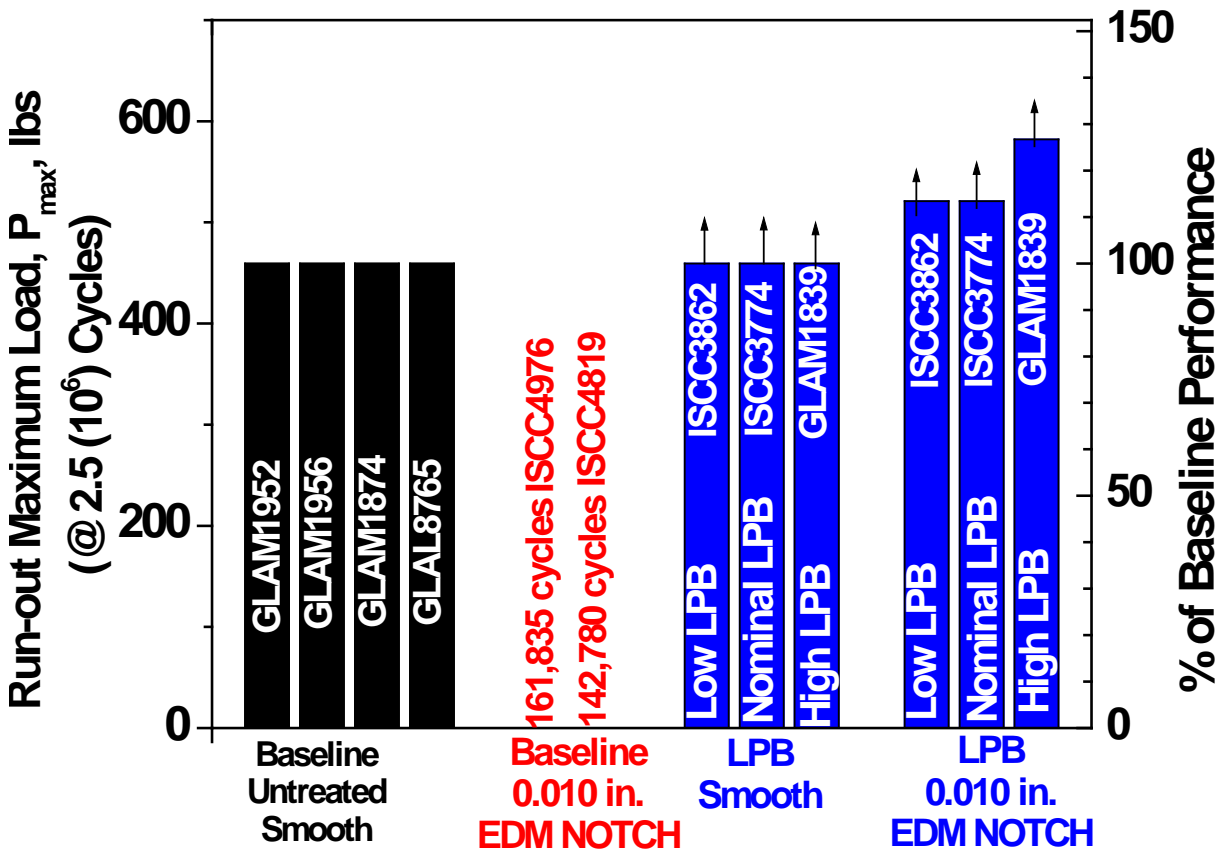

Figure 27 – Bar chart showing the relative fatigue performance of baseline, and LPB treated F404 Stage 1 Compressor blade dovetail contact faces with and without simulated fretting damage.

Similar fatigue performances have been reported for both the F402 Stage 1 compressor blade dovetail contact face and rotor post contact face. Figure 28 shows LPB treated contact face on the dovetail region of the compressor blade. The smooth polished surface is evident in this figure. Figure 29 shows the cantilever beam fatigue test set up, similar to that in Figure 26. The S-N data from the cantilever bending fatigue tests conducted on the dovetail section of the F402 Stage 1 compressor blades are shown in Figure 30. Fretting damage was simulated in these blades by an EDM notch of 0.1 in. surface length and 0.02 or 0.03 in. depth at the edge of contact, four (4) to six (6) times the maximum depth of a fretting induced microcrack. The benefits of LPB treatment are evident in this figure.



Figure 28 – LPB treated contact face of the dovetail in F402 Stage 1 compressor blade.



Figure 29 – Cantilever bending fatigue test set up for the F402 Stage 1 compressor blade.

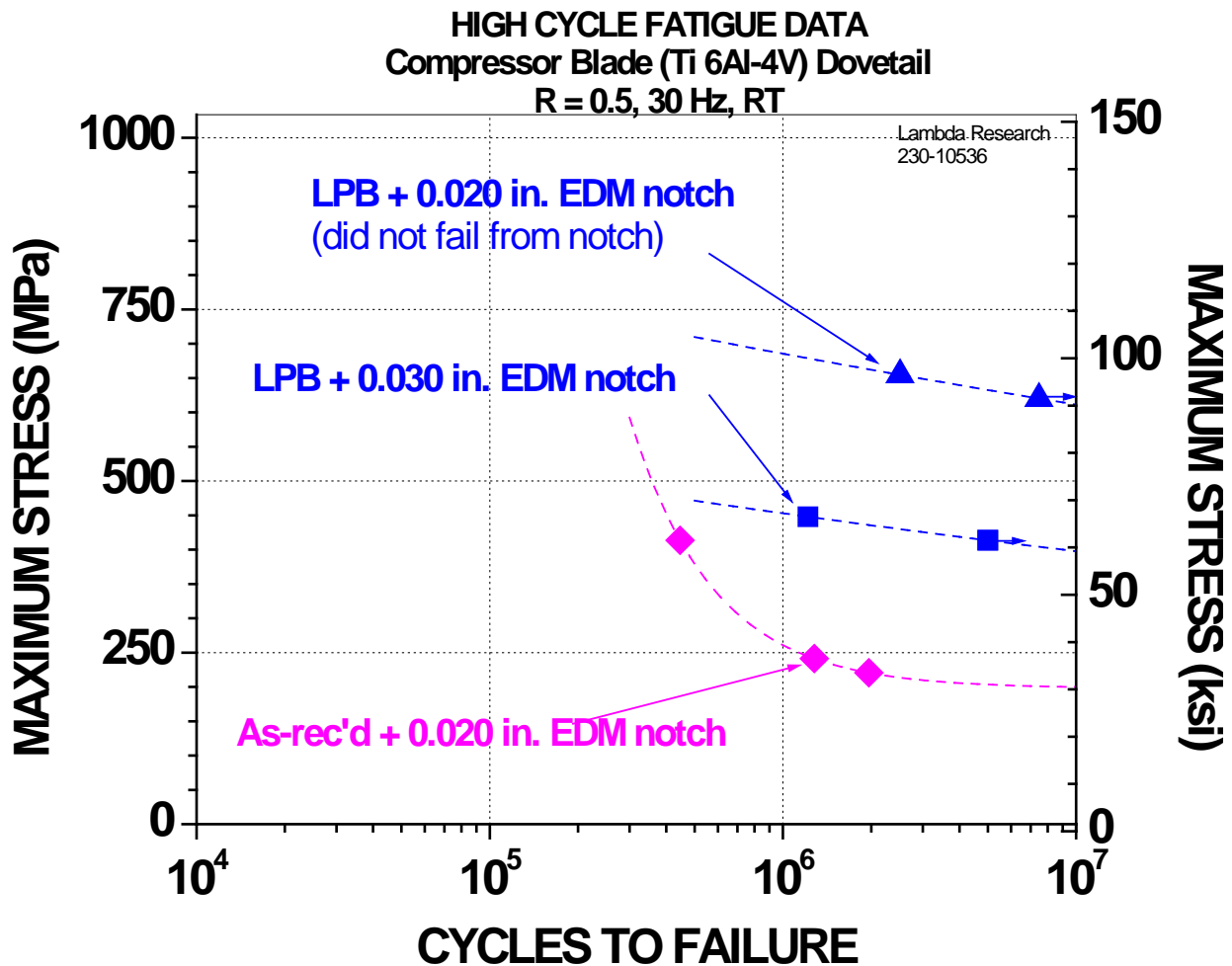

Figure 30 – S-N data showing the benefits of LPB treatment to mitigate simulated fretting damage in F402 Stage 1 Compressor blade dovetail section.

An LPB treated disk post was removed from the rotor and is shown in Figure 31. The smooth finish on the contact surface created by the LPB process is seen in this photograph. Figure 32 shows the cantilever beam fatigue test set up. The top contact surface is subjected to bending load and any damage leading to cracking on this contact surface will experience the classic mode I crack growth condition. As indicated earlier, typical fretting damage initiation starts through a set of mode II shear cracks, which are oriented at an angle of about 45° to the surface at the edge of contact and are shallow (< 0.003 in. deep). The main damage progression is through mode I crack growth starting from these initiated shear cracks. Figure 33 shows the fatigue life of F402 stage 1 compressor disk posts tested in cantilever bending mode. None of the LPB treated posts failed from the simulated fretting damage in the form of EDM notches (0.1 in surface length and 0.02 in. depth) at the edge of contact.



Figure 31 – An LPB treated disk post removed from the F402 Stage 1 rotor.

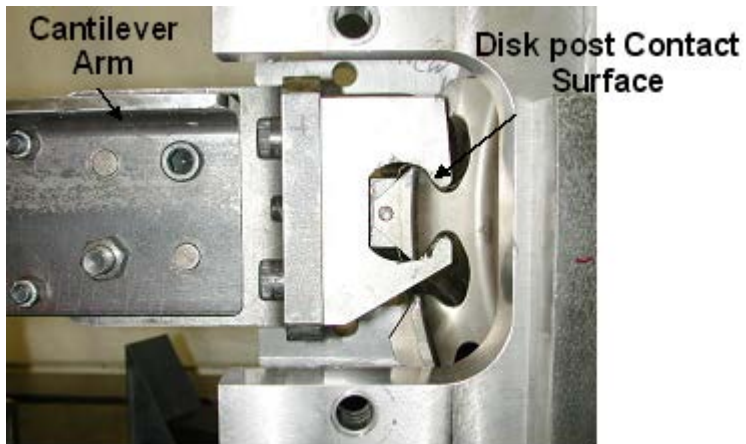

Figure 32 – Cantilever beam bending fatigue test set up for the F402 Stage 1 compressor disk post.

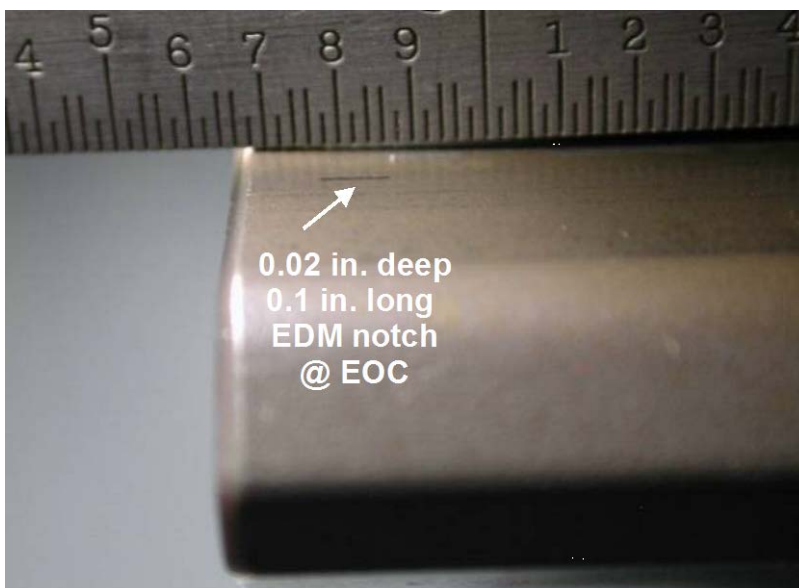

Figure 33 – Location and size of EDM notch on the contact surface of F402 Stage 1 compressor disk post to simulate damage at the edge of contact.

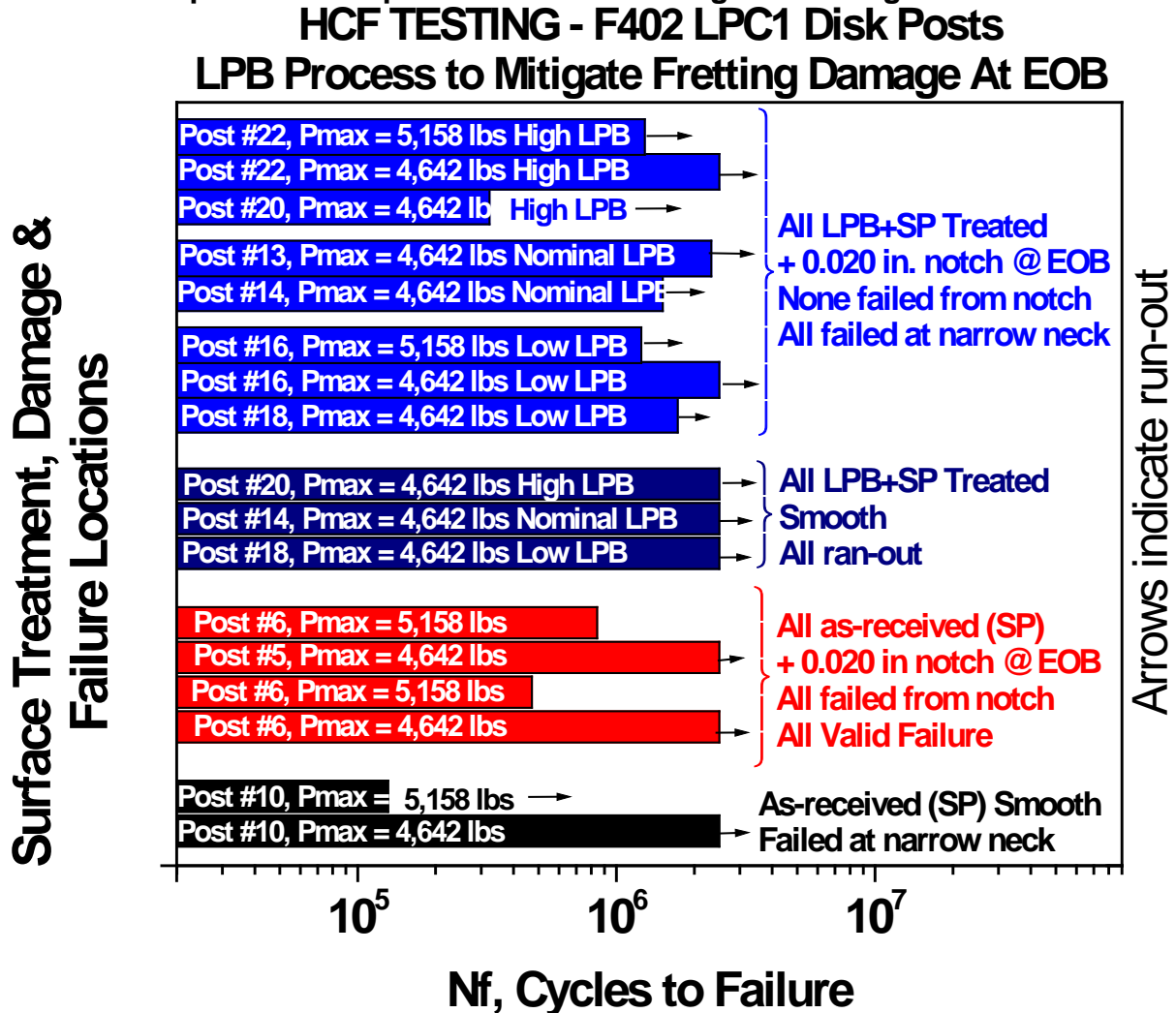

Figure 34 – Fatigue test results from F402 Stage 1 compressor disk posts tested in cantilever bending mode.

**SUMMARY:**

A great deal of basic and applied research has been conducted by numerous research groups over the last three decades to understand the fretting fatigue damage initiation and damage progression to failure in Ti-6Al-4V. Various test methods including axially loaded simple coupon specimens, 4-point bend specimens, dovetail feature specimens, and full-scale components have been used in these studies. Fretting damage manifests itself in a relatively simple way through the formation of microcracks at the edge of contact, initiated by severe very localized plastic deformation (slip) leading to the formation of shear bands, which lead to the creation of the Mode II microcracks. These microcracks are typically 0.002 in. to 0.005 in. deep, and since formed by a shear mechanism are typically oriented at nearly 45 degrees to the surface. Further crack

growth happens by the normal Mode I fatigue crack growth processes under the mean and alternating long range-applied stresses. It is quite evident from this literature review and analyses that the test results from various groups and test methods are quite comparable.

The effects of several different surface enhancement methods were shown to lead to varying degrees of success in mitigating fretting fatigue damage. The different coatings used in these studies seemed to make some improvement in the performance; however, significant improvements have been demonstrated when compressive residual stresses are used. Even among the compressive residual stress technologies, while the conventional shot peening shows some benefit over the untreated condition, it does not completely mitigate the fretting fatigue damage. This is associated with the shallow depth of compression and a tendency for the shot peened compression to be relaxed due to the localized deformation in the fretting zone. In comparison, technologies like LSP and LPB provide significant benefits. Of these two technologies, several studies conducted by the AFRL have repeatedly shown that LPB treated components outperform LSP treated components.

## **ACKNOWLEDGEMENT**

Support through SBIR programs and Phase III ID/IQ from NAVAIR (Ravi Ravindranath) to Lambda Technologies for all the data on LPB treated components reported here is appreciated.

---

## **REFERENCE:**

- 1 J. Meriaux, S. Fouvry, K. Kubiak, S. Deyber, "Characterization of Crack Nucleation in TA6V under Fretting - Fatigue loading using the potential drop technique", International Journal of Fatigue, 2010, <http://dx.doi.org/10.1016/j.ijfatigue.2010.03.008>
- 2 R.W. Neu, "The Fretting Fatigue Behavior of Ti-6Al-4V", Key Engineering Materials Vols. 378-379 (2008) pp 147-162
- 3 B.P. Conner, "Contact Fatigue – Life Prediction and Palliatives", PhD Dissertation, MIT, September 2002.
- 4 N.E. Frost, K.J. Marsh and L.P. Pook "Metal Fatigue", Section 6.6 Fretting, pp 364-370, Dover Publications, Mineola, NY, 1974.
- 5 Fretting Fatigue: Advances in Basic Understanding and Applications, edited by Yoshiharu Mutoh, Steven E. Kinyon, David W. Hoepfner, ASTM STP 1425, 2003, ASTM International, West Conshohokan, PA

- 
- 6 Fretting Fatigue: Current Technology and Practices, Editors: David W. Hoepfner, V. Chandrasekaran, and Charles B. Elliott III, editors, ASTM STP 1367, 2000, ASTM International, West Conshohocken, PA
- 7 Tribology International, Volume 42, Issue 9, Pages 1239-1404 (September 2009)  
Special Issue: Fifth International Symposium on Fretting Fatigue  
Edited by Helmi Attia
- 8 Tribology International, Volume 39, Issue 10, Pages 1003-1326 (October 2006)  
Special Issue: The Fourth International Symposium on Fretting Fatigue  
Edited by P.Kapsa, L. Vincent, V.Fridrici
- 9 S.C. Gordelier, and T.C. Chivers, "A literature review of palliatives for fretting fatigue", Wear, Volume 56, Issue 1, September 1979, Pages 177-190
- 10 Fretting fatigue, R.B. Waterhouse, International Materials Reviews, Volume 37, 1992, pp. 77-98(22)
- 11 Fretting fatigue in engineering alloys, T. C. Lindley, International Journal of Fatigue, Volume 19, Issue 93, June 1997, Pages 39-49
- 12 T.N. Farris, H. Murthy and J.F. Matlik, "4.11 - Fretting Fatigue", Comprehensive Structural Integrity, Volume 4, Pages 281-326, 2003,
- 13 David W. Hoepfner, "Fretting fatigue case studies of engineering components", Tribology International, Volume 39, Issue 10, October 2006, Pages 1271-1276
- 14 Recent developments in the understanding of fretting fatigue, D. Nowell \*, D. Dini, D.A. Hills, Engineering Fracture Mechanics 73 (2006) 207–222
- 15 R.W. Neu, "The Fretting Fatigue Behavior of Ti-6Al-4V", Key Engineering Materials Vols. 378-379 (2008) pp 147-162
- 16 ASTM Standard E2789, 2010, " Standard Guide for Fretting Fatigue Testing," ASTM International, West Conshohocken, PA, 2010, DOI: 10.1520/E2789-10, [www.astm.org](http://www.astm.org).
- 17 T.A. VENKATESH, B.P. CONNER, C.S. LEE, A.E. GIANNAKOPOULOS, T.C. LINDLEY, and S. SURESH, "An Experimental Investigation of Fretting Fatigue in Ti-6Al-4V: the Role of Contact Conditions and Microstructure", METALLURGICAL AND MATERIALS TRANSACTIONS A, VOLUME 32A, MAY 2001—pp1131-1146
- 18 A.L. Hutson, C. Nelson, T. Nicholas, "Characterization of Fretting Fatigue Crack Initiation Processes in Ti-6Al-4V", AFRL-ML-WP-TP2003-415, February 2003
- 19 N.R. Lovrich, "Fretting Fatigue of Ti-6Al-4V: Experimental Characterization and Simple Design Parameter", MS Thesis, Georgia Institute of Technology, July 2004
- 20 N. R. LOVRICH and R. W. NEU, "Effect of mean stress on fretting fatigue of Ti-6Al-4V on Ti-6Al-4V", Fatigue Fract Engng Mater Struct 29, 41–55, 2006
- 21 B. P. Conner, T. Nicholas, " Using a Dovetail Fixture to Study Fretting Fatigue and Fretting Palliatives", Journal of Engineering Materials and Technology, APRIL 2006, Vol. 128, pp133-141.



- 
- 22 B.B. Bartha, T. Nicholas and T.N. Farris, "Modeling of geometry effects in fretting fatigue", Tribology International, Volume 39, Issue 10, October 2006, Pages 1131-1141
- 23 P.J. Golden & A.L. Hutson & B.B. Bartha & T. Nicholas "Fatigue Loading and Life Prediction in Three Fretting Fatigue Fixtures", Experimental Mechanics (2008) 48:253–263
- 24 Patrick J. Golden, Alisha L. Hutson, Bence B. Bartha, and Theodore Nicholas," COMPARATIVE ANALYSIS OF THREE FRETTING FATIGUE FIXTURES (PREPRINT), AFRL-ML-WP-TP-2006-405, FEBRUARY 2006
- 25 M. Shepard, P. Prev y, N. Jayaraman, "Effect of Surface Treatments on Fretting Fatigue Performance of Ti-6Al-4V," Proceedings 8th National Turbine Engine HCF Conference, Monterey, CA, April 14-16, 2003
- 26 N.R. Lovrich, X. Huang and R.W. Neu, "EFFECT OF LOW PLASTICITY BURNISHING ON FRETTING FATIGUE OF Ti-6Al-4V" in: proc. 9th International Fatigue Congress, Atlanta, Georgia, USA, 14-19 May (2006).
- 27 Patrick J. Golden, Dennis Buchanan, and Sam Naboulsi, "INFLUENCE OF RESIDUAL STRESSES ON FRETTING FATIGUE LIFE PREDICTION IN Ti-6Al-4V (POSTPRINT)", January 2008, AFRL-RX-WP-TP-2009-4207
- 28 Hitoshi Soyamaa,\* , Dan O. Macodiyoa, and Shankar Mallb, "Compressive residual stress into titanium alloy using cavitation shotless peening method", Tribology Letters, Vol. 17, No. 3, October 2004, pp501-504
- 29 Patrick J. Golden, Alisha Hutson, Vasan Sundaram and James H. Arps, "Effect of surface treatments on fretting fatigue of Ti-6Al-4V", International Journal of Fatigue Volume 29, Issue 7, July 2007, Pages 1302-1310
- 30 P. Prev y, N. Jayaraman, R. Ravindranath, M. Shepard, "Mitigation of Fretting Fatigue Damage in Blade and Disk Pressure Faces with Low Plasticity Burnishing," Proceedings of Turbo Expo 2007, Montreal, Canada, May 14-17, 2007
- 31 B.P. Conner, "Contact Fatigue – Life Prediction and Palliatives", PhD Dissertation, MIT, September 2002.
- 32 Patrick J. Golden, Dennis Buchanan, and Sam Naboulsi, "INFLUENCE OF RESIDUAL STRESSES ON FRETTING FATIGUE LIFE PREDICTION IN Ti-6Al-4V (POSTPRINT)", January 2008, AFRL-RX-WP-TP-2009-4207
- 33 Patrick J. Golden and Michael J. Shepard, "LIFE PREDICTION OF FRETTING FATIGUE WITH ADVANCED SURFACE TREATMENTS (PREPRINT)", May 2006 AFRL-ML-WP-TP-2006-500
- 34 S. Srinivasan, D.B. Garcia, M.C. Gean, H. Murthy, and T.N. Farris, "Fretting fatigue of laser shock peened Ti-6Al-4V", Tribology International, Volume 42, Issue 9, September 2009, Pages 1324-1329
- 35 H. Murthy, G. Mseis and T.N. Farris, "Life estimation of Ti-6Al-4V specimens subjected to fretting fatigue and effect of surface treatments", Tribology International, Volume 42, Issue 9, September 2009, Pages 1304-1315

---

36 Kevin K. Liu and Michael R. Hill, "The effects of laser peening and shot peening on fretting fatigue in Ti-6Al-4V coupons", Tribology International Volume 42, Issue 9, September 2009, Pages 1250-1262

37 Enright MP, Chan KS, Moody JP, Golden P, Chandra R, Pentz A, 2009. "Influence of random residual stress on fretting fatigue risk of engine disks." AIAA Journal, AIAA (In Press). Also published in Proceedings, 50thAIAA Structures, Structural Dynamics, and Materials Conference, Palm Springs, California, May 4-9, 2009, Paper AIAA-2009-2302.

38 Michael P. Enright, Jonathan P. Moody, Patrick J. Golden, Ramesh Chandra and Alan C. Pentz, "Residual stress profiles for mitigating fretting fatigue in gas turbine engine disks", International Journal of Fatigue, Volume 32, Issue 5, May 2010, Pages 815-823

39 J. Edward Pope, "Rules of Thumb for Mechanical Engineers", Gulf Professional Publishing, Houston, TX 1997. p.232.

40 P. Prevéy, N. Jayaraman, R. Ravindranath, M. Shepard, "Mitigation of Fretting Fatigue Damage in Blade and Disk Pressure Faces with Low Plasticity Burnishing," Proceedings of Turbo Expo 2007, Montreal, Canada, May 14-17, 2007

41 P. Prevéy, N. Jayaraman, R. Ravindranath, "Use of Residual Compression in Design to Improve Damage Tolerance in Ti-6Al-4V Aero Engine Blade Dovetails," Proceedings of the 10th Nat, HCF Conference, New Orleans, LA, March 8-11, 2005.

42 N. Jayaraman, P.S. Prevéy, D.J. Hornbach, "MITIGATION OF FRETTING FATIGUE DAMAGE THROUGH LPB OF F404 ENGINE FAN BLADE DOVETAIL CONTACT SURFACE", Proceedings of the P-SAR Conference, Myrtle Beach, SC, March 17-21, 2008.

43 P.S. Prevey, N. Jayaraman "A Design Methodology to Take Credit for Residual Stresses in Fatigue Limited Designs", Journal of ASTM International, Vol.2 Issue 8, Sept. 2005.

44 AFGROW, Version 4.0012.15, 2008